



**ROHDE & SCHWARZ**

Test and Measurement  
Division

## **Operating Manual**

### **External Mixer Output for R&S FSEM or R&S FSEK**

#### **R&S FSE-B21**

1084.7243.02

Printed in the Federal  
Republic of Germany

Dear Customer,

throughout this manual, FSE-B21 is generally used as an abbreviation for option External Mixer Output R&S FSE-B21. The spectrum analyzers R&S FSEM20/21/30/31 and FSEK20/21/30/31 are abbreviated as FSE.

# Contents

<b>1</b>	<b>Connecting an External Mixer .....</b>	<b>1.1</b>
<b>2</b>	<b>Manual Operation .....</b>	<b>2.1</b>
2.1	<b>Menu Overview .....</b>	<b>2.1</b>
2.2	<b>Configuration of the External Mixer - INPUT Key.....</b>	<b>2.1</b>
2.2.1	BAND LOCK ON Mode.....	2.4
2.2.1.1	Selecting a Waveguide Band and Setting the Parameters .....	2.4
2.2.1.2	Conversion Loss Taken into Account as a Function of Frequency .....	2.8
2.2.1.2.1...	Editing a Table.....	2.10
2.2.2	BAND LOCK OFF Mode.....	2.16
2.2.3	Bias Current.....	2.17
2.2.4	Signal Identification.....	2.19
2.3	<b>Introductory Example of Operation .....</b>	<b>2.27</b>
<b>3</b>	<b>Remote Control.....</b>	<b>3.1</b>
3.1	<b>Description of IEC/IEEE-Bus Commands.....</b>	<b>3.1</b>
3.1.1	SENSE:CORRection - Subsystem.....	3.1
3.1.2	SENSE:MIXer - Subsystem .....	3.4
3.2	<b>Softkeys and Related IEC/IEEE-Bus Commands .....</b>	<b>3.7</b>
<b>4</b>	<b>Checking the Rated Specifications.....</b>	<b>4.1</b>
4.1	<b>Test Instructions.....</b>	<b>4.1</b>
4.1.1	Checking the LO Level .....	4.1
4.2	<b>Performance Test Report.....</b>	<b>4.3</b>

# Index

## A

AUTO ID	
Remarks concerning Signal Identification .....	2.22
with large spans .....	2.23

## B

BAND LOCK OFF mode .....	2.16
BAND LOCK ON mode .....	2.4
Bias current .....	2.18

## C

Conversion loss .....	2.8
Average .....	2.7
Frequency-dependent .....	2.8
Conversion loss table .....	2.15

## E

External Mixer .....	1.1
----------------------	-----

## F

Frequency range .....	2.1
Full-screen level .....	2.1

## H

Harmonic .....	2.5
----------------	-----

## K

Key	
INPUT .....	2.2

## M

Microwave band .....	2.4, 2.6
Mixer products	
at the same frequency .....	2.25
with low S/N ratio .....	2.23
with small span .....	2.23
Mixer, external .....	1.1
Connection .....	1.1

## O

Order of harmonic .....	2.6, 2.16
-------------------------	-----------

## R

Reference values .....	2.13
------------------------	------

## S

Signal identification .....	2.19
Softkey	
ACCEPT BIAS .....	2.7
AUTO ID .....	2.20
AUTO ID THRESHOLD .....	2.21
AVG CONV LOSS .....	2.16
AVG CONV LOSS HIGH .....	2.7
AVG CONV LOSS LOW .....	2.7
BAND .....	2.6
BAND LOCK ON/OFF .....	2.4, 2.16
BIAS .....	2.17
BIAS ON / OFF .....	2.18
CONV LOSS TABLE .....	2.8
COPY TABLE .....	2.10
DEFAULT SETTINGS .....	2.7
DELETE LINE .....	2.14
DELETE TABLE .....	2.9
EDIT TABLE .....	2.9
EXTERNAL MIXER .....	2.3
HARMONIC# .....	2.16
INSERT LINE .....	2.14
INTERNAL MIXER .....	2.2
LOAD TABLE .....	2.9
NEW TABLE .....	2.9
PAGE UP/PAGE DOWN .....	2.10, 2.14
PORTS 2/3 .....	2.6, 2.16
SAVE TABLE .....	2.14
SIGNAL ID .....	2.19
TABLE NAME .....	2.11
VALUES .....	2.13

## T

Tolerance for the comparison of test sweep	
and reference .....	2.22
Type of signal .....	2.22

## W

Waveguide band .....	2.4, 2.6
----------------------	----------



**Before putting the product into operation for the first time, make sure to read the following**



## **Safety Instructions**

Rohde & Schwarz makes every effort to keep the safety standard of its products up to date and to offer its customers the highest possible degree of safety. Our products and the auxiliary equipment required for them are designed and tested in accordance with the relevant safety standards. Compliance with these standards is continuously monitored by our quality assurance system. This product has been designed and tested in accordance with the EC Certificate of Conformity and has left the manufacturer's plant in a condition fully complying with safety standards. To maintain this condition and to ensure safe operation, observe all instructions and warnings provided in this manual. If you have any questions regarding these safety instructions, Rohde & Schwarz will be happy to answer them.

Furthermore, it is your responsibility to use the product in an appropriate manner. This product is designed for use solely in industrial and laboratory environments or in the field and must not be used in any way that may cause personal injury or property damage. You are responsible if the product is used for an intention other than its designated purpose or in disregard of the manufacturer's instructions. The manufacturer shall assume no responsibility for such use of the product.

The product is used for its designated purpose if it is used in accordance with its operating manual and within its performance limits (see data sheet, documentation, the following safety instructions). Using the products requires technical skills and knowledge of English. It is therefore essential that the products be used exclusively by skilled and specialized staff or thoroughly trained personnel with the required skills. If personal safety gear is required for using Rohde & Schwarz products, this will be indicated at the appropriate place in the product documentation.

### **Symbols and safety labels**

Observe operating instructions	Weight indication for units >18 kg	Danger of electric shock	Warning! Hot surface	PE terminal	Ground	Ground terminal	Attention! Electrostatic sensitive devices

Supply voltage ON/OFF	Standby indication	Direct current (DC)	Alternating current (AC)	Direct/alternating current (DC/AC)	Device fully protected by double/reinforced insulation

## Safety Instructions

Observing the safety instructions will help prevent personal injury or damage of any kind caused by dangerous situations. Therefore, carefully read through and adhere to the following safety instructions before putting the product into operation. It is also absolutely essential to observe the additional safety instructions on personal safety that appear in other parts of the documentation. In these safety instructions, the word "product" refers to all merchandise sold and distributed by Rohde & Schwarz, including instruments, systems and all accessories.

### Tags and their meaning

DANGER	This tag indicates a safety hazard with a high potential of risk for the user that can result in death or serious injuries.
WARNING	This tag indicates a safety hazard with a medium potential of risk for the user that can result in death or serious injuries.
CAUTION	This tag indicates a safety hazard with a low potential of risk for the user that can result in slight or minor injuries.
ATTENTION	This tag indicates the possibility of incorrect use that can cause damage to the product.
NOTE	This tag indicates a situation where the user should pay special attention to operating the product but which does not lead to damage.

These tags are in accordance with the standard definition for civil applications in the European Economic Area. Definitions that deviate from the standard definition may also exist. It is therefore essential to make sure that the tags described here are always used only in connection with the associated documentation and the associated product. The use of tags in connection with unassociated products or unassociated documentation can result in misinterpretations and thus contribute to personal injury or material damage.

### Basic safety instructions

1. The product may be operated only under the operating conditions and in the positions specified by the manufacturer. Its ventilation must not be obstructed during operation. Unless otherwise specified, the following requirements apply to Rohde & Schwarz products:  
prescribed operating position is always with the housing floor facing down, IP protection 2X, pollution severity 2, overvoltage category 2, use only in enclosed spaces, max. operation altitude max. 2000 m. Unless specified otherwise in the data sheet, a tolerance of  $\pm 10\%$  shall apply to the nominal voltage and of  $\pm 5\%$  to the nominal frequency.
2. Applicable local or national safety regulations and rules for the prevention of accidents must be observed in all work performed. The product may be opened only by authorized, specially trained personnel. Prior to performing any work on the product or opening the product, the product must be disconnected from the supply network. Any adjustments, replacements of parts, maintenance or repair must be carried out only by technical personnel authorized by Rohde & Schwarz. Only original parts may be used for replacing parts relevant to safety (e.g. power switches, power transformers, fuses). A safety test must always be performed after parts relevant to safety have been replaced (visual inspection, PE conductor test, insulation resistance measurement, leakage current measurement, functional test).
3. As with all industrially manufactured goods, the use of substances that induce an allergic reaction (allergens, e.g. nickel) such as aluminum cannot be generally excluded. If you develop an allergic reaction (such as a skin rash, frequent sneezing, red eyes or respiratory difficulties), consult a physician immediately to determine the cause.

## Safety Instructions

4. If products/components are mechanically and/or thermally processed in a manner that goes beyond their intended use, hazardous substances (heavy-metal dust such as lead, beryllium, nickel) may be released. For this reason, the product may only be disassembled, e.g. for disposal purposes, by specially trained personnel. Improper disassembly may be hazardous to your health. National waste disposal regulations must be observed.
5. If handling the product yields hazardous substances or fuels that must be disposed of in a special way, e.g. coolants or engine oils that must be replenished regularly, the safety instructions of the manufacturer of the hazardous substances or fuels and the applicable regional waste disposal regulations must be observed. Also observe the relevant safety instructions in the product documentation.
6. Depending on the function, certain products such as RF radio equipment can produce an elevated level of electromagnetic radiation. Considering that unborn life requires increased protection, pregnant women should be protected by appropriate measures. Persons with pacemakers may also be endangered by electromagnetic radiation. The employer is required to assess workplaces where there is a special risk of exposure to radiation and, if necessary, take measures to avert the danger.
7. Operating the products requires special training and intense concentration. Make certain that persons who use the products are physically, mentally and emotionally fit enough to handle operating the products; otherwise injuries or material damage may occur. It is the responsibility of the employer to select suitable personnel for operating the products.
8. Prior to switching on the product, it must be ensured that the nominal voltage setting on the product matches the nominal voltage of the AC supply network. If a different voltage is to be set, the power fuse of the product may have to be changed accordingly.
9. In the case of products of safety class I with movable power cord and connector, operation is permitted only on sockets with earthing contact and protective earth connection.
10. Intentionally breaking the protective earth connection either in the feed line or in the product itself is not permitted. Doing so can result in the danger of an electric shock from the product. If extension cords or connector strips are implemented, they must be checked on a regular basis to ensure that they are safe to use.
11. If the product has no power switch for disconnection from the AC supply, the plug of the connecting cable is regarded as the disconnecting device. In such cases, it must be ensured that the power plug is easily reachable and accessible at all times (length of connecting cable approx. 2 m). Functional or electronic switches are not suitable for providing disconnection from the AC supply. If products without power switches are integrated in racks or systems, a disconnecting device must be provided at the system level.
12. Never use the product if the power cable is damaged. By taking appropriate safety measures and carefully laying the power cable, ensure that the cable cannot be damaged and that no one can be hurt by e.g. tripping over the cable or suffering an electric shock.
13. The product may be operated only from TN/TT supply networks fused with max. 16 A.
14. Do not insert the plug into sockets that are dusty or dirty. Insert the plug firmly and all the way into the socket. Otherwise this can result in sparks, fire and/or injuries.
15. Do not overload any sockets, extension cords or connector strips; doing so can cause fire or electric shocks.
16. For measurements in circuits with voltages  $V_{rms} > 30 V$ , suitable measures (e.g. appropriate measuring equipment, fusing, current limiting, electrical separation, insulation) should be taken to avoid any hazards.
17. Ensure that the connections with information technology equipment comply with IEC 950/EN 60950.
18. Never remove the cover or part of the housing while you are operating the product. This will expose circuits and components and can lead to injuries, fire or damage to the product.

## Safety Instructions

19. If a product is to be permanently installed, the connection between the PE terminal on site and the product's PE conductor must be made first before any other connection is made. The product may be installed and connected only by a skilled electrician.
20. For permanently installed equipment without built-in fuses, circuit breakers or similar protective devices, the supply circuit must be fused in such a way that suitable protection is provided for users and products.
21. Do not insert any objects into the openings in the housing that are not designed for this purpose. Never pour any liquids onto or into the housing. This can cause short circuits inside the product and/or electric shocks, fire or injuries.
22. Use suitable overvoltage protection to ensure that no overvoltage (such as that caused by a thunderstorm) can reach the product. Otherwise the operating personnel will be endangered by electric shocks.
23. Rohde & Schwarz products are not protected against penetration of water, unless otherwise specified (see also safety instruction 1.). If this is not taken into account, there exists the danger of electric shock or damage to the product, which can also lead to personal injury.
24. Never use the product under conditions in which condensation has formed or can form in or on the product, e.g. if the product was moved from a cold to a warm environment.
25. Do not close any slots or openings on the product, since they are necessary for ventilation and prevent the product from overheating. Do not place the product on soft surfaces such as sofas or rugs or inside a closed housing, unless this is well ventilated.
26. Do not place the product on heat-generating devices such as radiators or fan heaters. The temperature of the environment must not exceed the maximum temperature specified in the data sheet.
27. Batteries and storage batteries must not be exposed to high temperatures or fire. Keep batteries and storage batteries away from children. If batteries or storage batteries are improperly replaced, this can cause an explosion (warning: lithium cells). Replace the battery or storage battery only with the matching Rohde & Schwarz type (see spare parts list). Batteries and storage batteries are hazardous waste. Dispose of them only in specially marked containers. Observe local regulations regarding waste disposal. Do not short-circuit batteries or storage batteries.
28. Please be aware that in the event of a fire, toxic substances (gases, liquids etc.) that may be hazardous to your health may escape from the product.
29. Please be aware of the weight of the product. Be careful when moving it; otherwise you may injure your back or other parts of your body.
30. Do not place the product on surfaces, vehicles, cabinets or tables that for reasons of weight or stability are unsuitable for this purpose. Always follow the manufacturer's installation instructions when installing the product and fastening it to objects or structures (e.g. walls and shelves).
31. Handles on the products are designed exclusively for personnel to hold or carry the product. It is therefore not permissible to use handles for fastening the product to or on means of transport such as cranes, fork lifts, wagons, etc. The user is responsible for securely fastening the products to or on the means of transport and for observing the safety regulations of the manufacturer of the means of transport. Noncompliance can result in personal injury or material damage.
32. If you use the product in a vehicle, it is the sole responsibility of the driver to drive the vehicle safely. Adequately secure the product in the vehicle to prevent injuries or other damage in the event of an accident. Never use the product in a moving vehicle if doing so could distract the driver of the vehicle. The driver is always responsible for the safety of the vehicle; the manufacturer assumes no responsibility for accidents or collisions.
33. If a laser product (e.g. a CD/DVD drive) is integrated in a Rohde & Schwarz product, do not use any other settings or functions than those described in the documentation. Otherwise this may be hazardous to your health, since the laser beam can cause irreversible damage to your eyes. Never try to take such products apart, and never look into the laser beam.





**Por favor lea imprescindiblemente antes de la primera puesta en funcionamiento las siguientes informaciones de seguridad**



## Informaciones de seguridad

Es el principio de Rohde & Schwarz de tener a sus productos siempre al día con los estándares de seguridad y de ofrecer a sus clientes el máximo grado de seguridad. Nuestros productos y todos los equipos adicionales son siempre fabricados y examinados según las normas de seguridad vigentes. Nuestra sección de gestión de la seguridad de calidad controla constantemente que sean cumplidas estas normas. Este producto ha sido fabricado y examinado según el comprobante de conformidad adjunto según las normas de la CE y ha salido de nuestra planta en estado impecable según los estándares técnicos de seguridad. Para poder preservar este estado y garantizar un funcionamiento libre de peligros, deberá el usuario atenerse a todas las informaciones, informaciones de seguridad y notas de alerta. Rohde&Schwarz está siempre a su disposición en caso de que tengan preguntas referentes a estas informaciones de seguridad.

Además queda en la responsabilidad del usuario utilizar el producto en la forma debida. Este producto solamente fue elaborado para ser utilizado en la industria y el laboratorio o para fines de campo y de ninguna manera deberá ser utilizado de modo que alguna persona/cosa pueda ser dañada. El uso del producto fuera de sus fines definidos o despreciando las informaciones de seguridad del fabricante queda en la responsabilidad del usuario. El fabricante no se hace en ninguna forma responsable de consecuencias a causa del maluso del producto.

Se parte del uso correcto del producto para los fines definidos si el producto es utilizado dentro de las instrucciones del correspondiente manual del uso y dentro del margen de rendimiento definido (ver hoja de datos, documentación, informaciones de seguridad que siguen). El uso de los productos hace necesarios conocimientos profundos y el conocimiento del idioma inglés. Por eso se deberá tener en cuenta de exclusivamente autorizar para el uso de los productos a personas péritas o debidamente minuciosamente instruidas con los conocimientos citados. Si fuera necesaria indumentaria de seguridad para el uso de productos de R&S, encontrará la información debida en la documentación del producto en el capítulo correspondiente.

### Símbolos y definiciones de seguridad

Ver manual de instrucciones del uso	Informaciones para maquinaria con un peso de > 18kg	Peligro de golpe de corriente	¡Advertencia! Superficie caliente	Conexión a conductor protector	Conexión a tierra	Conexión a masa conductora	¡Cuidado! Elementos de construcción con peligro de carga electrostática

potencia EN MARCHA/PARADA	Indicación Stand-by	Corriente continua DC	Corriente alterna AC	Corriente continua/alterna DC/AC	El aparato está protegido en su totalidad por un aislamiento de doble refuerzo

## Informaciones de seguridad

Tener en cuenta las informaciones de seguridad sirve para tratar de evitar daños y peligros de toda clase. Es necesario de que se lean las siguientes informaciones de seguridad concienzudamente y se tengan en cuenta debidamente antes de la puesta en funcionamiento del producto. También deberán ser tenidas en cuenta las informaciones para la protección de personas que encontrarán en otro capítulo de esta documentación y que también son obligatorias de seguir. En las informaciones de seguridad actuales hemos juntado todos los objetos vendidos por Rohde&Schwarz bajo la denominación de „producto“, entre ellos también aparatos, instalaciones así como toda clase de accesorios.

### Palabras de señal y su significado

PELIGRO	Indica un punto de peligro con gran potencial de riesgo para el usuario. Punto de peligro que puede llevar hasta la muerte o graves heridas.
ADVERTENCIA	Indica un punto de peligro con un potencial de riesgo mediano para el usuario. Punto de peligro que puede llevar hasta la muerte o graves heridas .
ATENCIÓN	Indica un punto de peligro con un potencial de riesgo pequeño para el usuario. Punto de peligro que puede llevar hasta heridas leves o pequeñas
CUIDADO	Indica la posibilidad de utilizar mal el producto y a consecuencia dañarlo.
INFORMACIÓN	Indica una situación en la que deberían seguirse las instrucciones en el uso del producto, pero que no consecuentemente deben de llevar a un daño del mismo.

Las palabras de señal corresponden a la definición habitual para aplicaciones civiles en el ámbito de la comunidad económica europea. Pueden existir definiciones diferentes a esta definición. Por eso se debiera tener en cuenta que las palabras de señal aquí descritas sean utilizadas siempre solamente en combinación con la correspondiente documentación y solamente en combinación con el producto correspondiente. La utilización de las palabras de señal en combinación con productos o documentaciones que no les correspondan puede llevar a malinterpretaciones y tener por consecuencia daños en personas u objetos.

### Informaciones de seguridad elementales

1. El producto solamente debe ser utilizado según lo indicado por el fabricante referente a la situación y posición de funcionamiento sin que se obstruya la ventilación. Si no se convino de otra manera, es para los productos R&S válido lo que sigue: como posición de funcionamiento se define principalmente la posición con el suelo de la caja para abajo , modo de protección IP 2X, grado de suciedad 2, categoría de sobrecarga eléctrica 2, utilizar solamente en estancias interiores, utilización hasta 2000 m sobre el nivel del mar.  
A menos que se especifique otra cosa en la hoja de datos, se aplicará una tolerancia de  $\pm 10\%$  sobre el voltaje nominal y de  $\pm 5\%$  sobre la frecuencia nominal.
2. En todos los trabajos deberán ser tenidas en cuenta las normas locales de seguridad de trabajo y de prevención de accidentes. El producto solamente debe de ser abierto por personal périto autorizado. Antes de efectuar trabajos en el producto o abrirlo deberá este ser desconectado de la corriente. El ajuste, el cambio de partes, la manutención y la reparación deberán ser solamente efectuadas por electricistas autorizados por R&S. Si se reponen partes con importancia para los aspectos de seguridad (por ejemplo el enchufe, los transformadores o los fusibles), solamente podrán ser sustituidos por partes originales. Despues de cada recambio de partes elementales para la seguridad deberá ser efectuado un control de

## Informaciones de seguridad

- seguridad (control a primera vista, control de conductor protector, medición de resistencia de aislamiento, medición de medición de la corriente conductora, control de funcionamiento).
3. Como en todo producto de fabricación industrial no puede ser excluido en general de que se produzcan al usarlo elementos que puedan generar alergias, los llamados elementos alergénicos (por ejemplo el níquel). Si se produjeran en el trato con productos R&S reacciones alérgicas, como por ejemplo urticaria, estornudos frecuentes, irritación de la conjuntiva o dificultades al respirar, se deberá consultar inmediatamente a un médico para averiguar los motivos de estas reacciones.
  4. Si productos / elementos de construcción son tratados fuera del funcionamiento definido de forma mecánica o térmica, pueden generarse elementos peligrosos (polvos de sustancia de metales pesados como por ejemplo plomo, berilio, níquel). La partición elemental del producto, como por ejemplo sucede en el tratamiento de materias residuales, debe de ser efectuada solamente por personal especializado para estos tratamientos. La partición elemental efectuada inadecuadamente puede generar daños para la salud. Se deben tener en cuenta las directivas nacionales referentes al tratamiento de materias residuales.
  5. En el caso de que se produjeran agentes de peligro o combustibles en la aplicación del producto que debieran de ser transferidos a un tratamiento de materias residuales, como por ejemplo agentes refrigerantes que deben ser repuestos en periodos definidos, o aceites para motores, deberán ser tenidas en cuenta las prescripciones de seguridad del fabricante de estos agentes de peligro o combustibles y las regulaciones regionales para el tratamiento de materias residuales. Cuiden también de tener en cuenta en caso dado las prescripciones de seguridad especiales en la descripción del producto.
  6. Ciertos productos, como por ejemplo las instalaciones de radiación HF, pueden a causa de su función natural, emitir una radiación electromagnética aumentada. En vista a la protección de la vida en desarrollo deberían ser protegidas personas embarazadas debidamente. También las personas con un bypass pueden correr peligro a causa de la radiación electromagnética. El empresario está comprometido a valorar y señalar áreas de trabajo en las que se corra un riesgo de exposición a radiaciones aumentadas de riesgo aumentado para evitar riesgos.
  7. La utilización de los productos requiere instrucciones especiales y una alta concentración en el manejo. Debe de ponerse por seguro de que las personas que manejen los productos estén a la altura de los requerimientos necesarios referente a sus aptitudes físicas, psíquicas y emocionales, ya que de otra manera no se pueden excluir lesiones o daños de objetos. El empresario lleva la responsabilidad de seleccionar el personal usuario apto para el manejo de los productos.
  8. Antes de la puesta en marcha del producto se deberá tener por seguro de que la tensión preseleccionada en el producto equivalga a la del la red de distribución. Si es necesario cambiar la preselección de la tensión también se deberán en caso dabo cambiar los fusibles correspondientes del producto.
  9. Productos de la clase de seguridad I con alimentación móvil y enchufe individual de producto solamente deberán ser conectados para el funcionamiento a tomas de corriente de contacto de seguridad y con conductor protector conectado.
  10. Queda prohibida toda clase de interrupción intencionada del conductor protector, tanto en la toma de corriente como en el mismo producto ya que puede tener como consecuencia el peligro de golpe de corriente por el producto. Si se utilizaran cables o enchufes de extensión se deberá poner al seguro, que es controlado su estado técnico de seguridad.
  11. Si el producto no está equipado con un interruptor para desconectarlo de la red, se deberá considerar el enchufe del cable de distribución como interruptor. En estos casos deberá asegurar de que el enchufe sea de fácil acceso y nabejo (medida del cable de distribución aproximadamente 2 m). Los interruptores de función o electrónicos no son aptos para el corte de la red eléctrica. Si los productos sin interruptor están integrados en construcciones o instalaciones, se deberá instalar el interruptor al nivel de la instalación.

## Informaciones de seguridad

12. No utilice nunca el producto si está dañado el cable eléctrico. Asegure a través de las medidas de protección y de instalación adecuadas de que el cable de eléctrico no pueda ser dañado o de que nadie pueda ser dañado por él, por ejemplo al tropezar o por un golpe de corriente.
13. Solamente está permitido el funcionamiento en redes de distribución TN/TT aseguradas con fusibles de como máximo 16 A.
14. Nunca conecte el enchufe en tomas de corriente sucias o llenas de polvo. Introduzca el enchufe por completo y fuertemente en la toma de corriente. Si no tiene en consideración estas indicaciones se arriesga a que se originen chispas, fuego y/o heridas.
15. No sobrecargue las tomas de corriente, los cables de extensión o los enchufes de extensión ya que esto pudiera causar fuego o golpes de corriente.
16. En las mediciones en circuitos de corriente con una tensión de entrada de  $U_{eff} > 30 \text{ V}$  se deberá tomar las precauciones debidas para impedir cualquier peligro (por ejemplo medios de medición adecuados, seguros, limitación de tensión, corte protector, aislamiento etc.).
17. En caso de conexión con aparatos de la técnica informática se deberá tener en cuenta que estos cumplan los requisitos de la EC950/EN60950.
18. Nunca abra la tapa o parte de ella si el producto está en funcionamiento. Esto pone a descubierto los cables y componentes eléctricos y puede causar heridas, fuego o daños en el producto.
19. Si un producto es instalado fijamente en un lugar, se deberá primero conectar el conductor protector fijo con el conductor protector del aparato antes de hacer cualquier otra conexión. La instalación y la conexión deberán ser efectuadas por un electricista especializado.
20. En caso de que los productos que son instalados fijamente en un lugar sean sin protector implementado, autointerruptor o similares objetos de protección, deberá la toma de corriente estar protegida de manera que los productos o los usuarios estén suficientemente protegidos.
21. Por favor, no introduzca ningún objeto que no esté destinado a ello en los orificios de la caja del aparato. No vierta nunca ninguna clase de líquidos sobre o en la caja. Esto puede producir corto circuitos en el producto y/o puede causar golpes de corriente, fuego o heridas.
22. Asegúrese con la protección adecuada de que no pueda originarse en el producto una sobrecarga por ejemplo a causa de una tormenta. Si no se verá el personal que lo utilice expuesto al peligro de un golpe de corriente.
23. Los productos R&S no están protegidos contra el agua si no es que exista otra indicación, ver también punto 1. Si no se tiene en cuenta esto se arriesga el peligro de golpe de corriente o de daños en el producto lo cual también puede llevar al peligro de personas.
24. No utilice el producto bajo condiciones en las que pueda producirse y se hayan producido líquidos de condensación en o dentro del producto como por ejemplo cuando se desplaza el producto de un lugar frío a un lugar caliente.
25. Por favor no cierre ninguna ranura u orificio del producto, ya que estas son necesarias para la ventilación e impiden que el producto se caliente demasiado. No pongan el producto encima de materiales blandos como por ejemplo sofás o alfombras o dentro de una caja cerrada, si esta no está suficientemente ventilada.
26. No ponga el producto sobre aparatos que produzcan calor, como por ejemplo radiadores o calentadores. La temperatura ambiental no debe superar la temperatura máxima especificada en la hoja de datos.

## Informaciones de seguridad

27. Baterías y acumuladores no deben de ser expuestos a temperaturas altas o al fuego. Guardar baterías y acumuladores fuera del alcance de los niños. Si las baterías o los acumuladores no son cambiados con la debida atención existirá peligro de explosión (atención celulas de Litio). Cambiar las baterías o los acumuladores solamente por los del tipo R&S correspondiente (ver lista de piezas de recambio). Baterías y acumuladores son deshechos problemáticos. Por favor tirenlos en los recipientes especiales para este fin. Por favor tengan en cuenta las prescripciones nacionales de cada país referente al tratamiento de deshechos. Nunca sometan las baterías o acumuladores a un corto circuito.
28. Tengan en consideración de que en caso de un incendio pueden escaparse gases tóxicos del producto, que pueden causar daños a la salud.
29. Por favor tengan en cuenta que en caso de un incendio pueden desprenderse del producto agentes venenosos (gases, líquidos etc.) que pueden generar daños a la salud.
30. No sitúe el producto encima de superficies, vehículos, estantes o mesas, que por sus características de peso o de estabilidad no sean aptas para él. Siga siempre las instrucciones de instalación del fabricante cuando instale y asegure el producto en objetos o estructuras (por ejemplo paredes y estantes).
31. Las asas instaladas en los productos sirven solamente de ayuda para el manejo que solamente está previsto para personas. Por eso no está permitido utilizar las asas para la sujecion en o sobre medios de transporte como por ejemplo grúas, carretillas elevadoras de horquilla, carros etc. El usuario es responsable de que los productos sean sujetados de forma segura a los medios de transporte y de que las prescripciones de seguridad del fabricante de los medios de transporte sean tenidas en cuenta. En caso de que no se tengan en cuenta pueden causarse daños en personas y objetos.
32. Si llega a utilizar el producto dentro de un vehículo, queda en la responsabilidad absoluta del conductor que conducir el vehículo de manera segura. Asegure el producto dentro del vehículo debidamente para evitar en caso de un accidente las lesiones u otra clase de daños. No utilice nunca el producto dentro de un vehículo en movimiento si esto pudiera distraer al conductor. Siempre queda en la responsabilidad absoluta del conductor la seguridad del vehículo y el fabricante no asumirá ninguna clase de responsabilidad por accidentes o colisiones.
33. Dado el caso de que esté integrado un producto de laser en un producto R&S (por ejemplo CD/DVD-ROM) no utilice otras instalaciones o funciones que las descritas en la documentación. De otra manera pondrá en peligro su salud, ya que el rayo laser puede dañar irreversiblemente sus ojos. Nunca trate de descomponer estos productos. Nunca mire dentro del rayo laser.



## Certified Quality System

**DIN EN ISO 9001 : 2000**  
**DIN EN 9100 : 2003**  
**DIN EN ISO 14001 : 1996**

**DQS REG. NO 001954 QM/ST UM**

### QUALITÄTSZERTIFIKAT

*Sehr geehrter Kunde,*

Sie haben sich für den Kauf eines Rohde & Schwarz-Produktes entschieden. Hiermit erhalten Sie ein nach modernsten Fertigungsmethoden hergestelltes Produkt. Es wurde nach den Regeln unseres Managementsystems entwickelt, gefertigt und geprüft.

Das Rohde & Schwarz Managementsystem ist zertifiziert nach:

DIN EN ISO 9001:2000  
DIN EN 9100:2003  
DIN EN ISO 14001:1996

### CERTIFICATE OF QUALITY

*Dear Customer,*

you have decided to buy a Rohde & Schwarz product. You are thus assured of receiving a product that is manufactured using the most modern methods available. This product was developed, manufactured and tested in compliance with our quality management system standards.

The Rohde & Schwarz quality management system is certified according to:

DIN EN ISO 9001:2000  
DIN EN 9100:2003  
DIN EN ISO 14001:1996

### CERTIFICAT DE QUALITÉ

*Cher Client,*

vous avez choisi d'acheter un produit Rohde & Schwarz. Vous disposez donc d'un produit fabriqué d'après les méthodes les plus avancées. Le développement, la fabrication et les tests respectent nos normes de gestion qualité.

Le système de gestion qualité de Rohde & Schwarz a été homologué conformément aux normes:

DIN EN ISO 9001:2000  
DIN EN 9100:2003  
DIN EN ISO 14001:1996



**ROHDE & SCHWARZ**







Certificate No.: 9502052

This is to certify that:

Equipment type	Stock No.	Designation
FSE-B1	1073.4990.02	Color Display
FSE-B10	1066.4769.02	Tracking Generator
FSE-B11	1066.4917.02	Tracking Generator
FSE-B12	1066.5065.02	Output Attenuator
FSE-B13	1119.6499.02	1 dB Input Attenuator
FSE-B15	1073.5696.02/.03	Computer Function
FSE-B16	1073.5973.02/.03/.04	Ethernet Interface
FSE-B17	1066.4017.02	2nd IEC BUS Interface
FSE-B18	1088.6993.02	Removeable Harddrive
FSE-B19	1088.7248.xx	Second Harddisk
FSE-B2	1073.5044.02	7 GHz Frequency Extension
FSE-B21	1084.7243.02	External Mixer Output
FSE-B23	1088.7348.02	741,4 MHz Broadband Output
FSE-B24	1106.3680.02	44 GHz Frequency Extension
FSE-B3	1073.5244.02	TV Demodulator
FSE-B4	1073.5396.02	OCXO 10 MHz and Low Phase Noise
FSE-B7	1066.4317.02	Signal Vectoranalysis
FSE-B77	1102.8493.02	Signal Vectoranalysis
FSE-B8	1066.4469.02	Tracking Generator
FSE-B9	1066.4617.02	Tracking Generator
FSE-Z2	1084.7043.02	PS/2 Mouse

complies with the provisions of the Directive of the Council of the European Union on the approximation of the laws of the Member States

- relating to electromagnetic compatibility  
(89/336/EEC revised by 91/263/EEC, 92/31/EEC, 93/68/EEC)

Conformity is proven by compliance with the following standards:

EN55011 : 1998 + A1 : 1999, Klasse B  
EN61000-3-2 : 1995 + A1 : 1998 + A2 : 1998 + A14 : 2000  
EN61000-3-3 : 1995  
EN50082-1 : 1992

Affixing the EC conformity mark as from 1995

**ROHDE & SCHWARZ GmbH & Co. KG**  
**Mühldorfstr. 15, D-81671 München**

Munich, 2001-01-11

Central Quality Management FS-QZ / Becker



# Customer Support

## Technical support – where and when you need it

For quick, expert help with any Rohde & Schwarz equipment, contact one of our Customer Support Centers. A team of highly qualified engineers provides telephone support and will work with you to find a solution to your query on any aspect of the operation, programming or applications of Rohde & Schwarz equipment.

## Up-to-date information and upgrades

To keep your Rohde & Schwarz equipment always up-to-date, please subscribe to our electronic newsletter at

<http://www.rohde-schwarz.com/www/response.nsf/newsletterpreselection>

or request the desired information and upgrades via email from your Customer Support Center (addresses see below).

## Feedback

We want to know if we are meeting your support needs. If you have any comments please email us and let us know [CustomerSupport.Feedback@rohde-schwarz.com](mailto:CustomerSupport.Feedback@rohde-schwarz.com).

---

### USA & Canada

Monday to Friday (except US public holidays)

8:00 AM – 8:00 PM Eastern Standard Time (EST)

Tel. from USA 888-test-rsa (888-837-8772) (opt 2)

From outside USA +1 410 910 7800 (opt 2)

Fax +1 410 910 7801

E-mail [Customer.Support@rsa.rohde-schwarz.com](mailto:Customer.Support@rsa.rohde-schwarz.com)

### East Asia

Monday to Friday (except Singaporean public holidays)

8:30 AM – 6:00 PM Singapore Time (SGT)

Tel. +65 6 513 0488

Fax +65 6 846 1090

E-mail [Customersupport.asia@rohde-schwarz.com](mailto:Customersupport.asia@rohde-schwarz.com)

### Rest of the World

Monday to Friday (except German public holidays)

08:00 – 17:00 Central European Time (CET)

Tel. from Europe +49 (0) 180 512 42 42

From outside Europe +49 89 4129 13776

Fax +49 (0) 89 41 29 637 78

E-mail [CustomerSupport@rohde-schwarz.com](mailto:CustomerSupport@rohde-schwarz.com)





# Adressen/Addresses

## FIRMENSITZ/HEADQUARTERS

(Tel) Phone  
(Fax) Fax  
E-mail

Rohde & Schwarz GmbH & Co. KG  
Mühlendorfstraße 15 · D-81671 München  
Postfach 80 14 69 · D-81614 München

(Tel) +49 (89) 41 29-0  
(Fax) +49 89 4129-121 64  
info@rohde-schwarz.com

## WERKE/PLANTS

Rohde & Schwarz Messgerätebau GmbH  
Riedbachstraße 58 · D-87700 Memmingen  
Postfach 1652 · D-87686 Memmingen

(Tel) +49 (8331) 108-0  
(Fax) +49 (8331) 108-11 24  
info.rsdmb@rohde-schwarz.com

Rohde & Schwarz GmbH & Co. KG  
Werk Teisnach  
Kaikenrieder Straße 27 · D-94244 Teisnach  
Postfach 1149 · D-94240 Teisnach

(Tel) +49 (9923) 857-0  
(Fax) +49 (9923) 857-11 74  
info.rsdts@rohde-schwarz.com

Rohde & Schwarz GmbH & Co. KG  
Dienstleistungszentrum Köln  
Graf-Zeppelin-Straße 18 · D-51147 Köln  
Postfach 98 02 60 · D-51130 Köln

(Tel) +49 (2203) 49-0  
(Fax) +49 (2203) 49 51-229  
info.rsd@rohde-schwarz.com  
schwarz.com-service.rsd@rohde-schwarz.com

## TOCHTERUNTERNEHMEN/SUBSIDIARIES

Rohde & Schwarz Vertriebs-GmbH  
Mühlendorfstraße 15 · D-81671 München  
Postfach 80 14 69 · D-81614 München

(Tel) +49 (89) 41 29-137 74  
(Fax) +49 (89) 41 29-137 77  
customersupport@rohde-schwarz.com

Rohde & Schwarz International GmbH  
Mühlendorfstraße 15 · D-81671 München  
Postfach 80 14 60 · D-81614 München

(Tel) +49 (89) 41 29-129 84  
(Fax) +49 (89) 41 29-120 50  
info.rusis@rohde-schwarz.com

Rohde & Schwarz Engineering and Sales GmbH  
Mühlendorfstraße 15 · D-81671 München  
Postfach 80 14 29 · D-81614 München

(Tel) +49 (89) 41 29-137 11  
(Fax) +49 (89) 41 29-137 23  
info.rse@rohde-schwarz.com

R&S BICK Mobilfunk GmbH  
Fritz-Hahne-Str. 7 · D-31848 Bad Münder  
Postfach 2062 · D-31844 Bad Münder

(Tel) +49 (5042) 998-0  
(Fax) +49 (5042) 998-105  
info.rsbeck@rohde-schwarz.com

Rohde & Schwarz FTK GmbH  
Wendenschlossstraße 168, Haus 28  
D-12557 Berlin

(Tel) +49 (30) 658 91-122  
(Fax) +49 (30) 655 50-221  
info.ftk@rohde-schwarz.com

Rohde & Schwarz SIT GmbH  
Agastraße 3  
D-12489 Berlin

(Tel) +49 (30) 658 84-0  
(Fax) +49 (30) 658 84-183  
info.sit@rohde-schwarz.com

R&S Systems GmbH  
Graf-Zeppelin-Straße 18 · D-51147 Köln  
Postfach 98 02 60 · D-51130 Köln

(Tel) +49 (2203) 49-5 23 25  
(Fax) +49 (2203) 49-5 23 36  
info.rssys@rohde-schwarz.com

## ADRESSEN WELTWEIT/ADDRESSES WORLDWIDE

**Albania** siehe/see Austria

**Algeria** Rohde & Schwarz  
Bureau d'Alger  
5B Place de Laperrine  
16035 Hydra-Alger

(Tel) +213 (21) 48 20 18  
(Fax) +213 (21) 69 46 08

**Antilles (Neth.)** siehe / see Mexico

**Argentina** Precision Electronica S.R.L.  
Av. Pde Julio A. Roca 710 - 6° Piso  
1067 Buenos Aires

(Tel) +541 (14) 331 10 67  
(Fax) +541 (14) 334 51 11  
alberto.lombardi@prec-elec.com.ar

**Australia** Rohde & Schwarz (Australia) Pty. Ltd.  
Sales Support  
Unit 6  
2-8 South Street  
Rydalmere, N.S.W. 2116

(Tel) +61 (2) 88 45 41 00  
(Fax) +61 (2) 96 38 39 88  
sales@rsa.us.rohde-schwarz.com

**Austria** Rohde & Schwarz-Österreich Ges.m.b.H.  
Am Europlatz 3  
Gebäude B  
1120 Wien

(Tel) +43 (1) 602 61 41-0  
(Fax) +43 (1) 602 61 41-14  
rs-austria@rsoe.rohde-schwarz.com

**Azerbaijan** Rohde & Schwarz Azerbaijan  
Liaison Office Baku  
ISR Plaza, 5th floor  
340 Nizami Str.  
370000 Baku

(Tel) +994 (12) 93 31 38  
(Fax) +994 (12) 93 03 14  
rs-azerbaijan@rsd.rohde-schwarz.com

**Bangladesh** BIL Consortium Ltd.  
Corporate Office  
House-33, Road-4, Block-F  
Banani, Dhaka-1213

(Tel) +880 (2) 881 06 53  
(Fax) +880 (2) 882 82 91

**Barbados** siehe / see Mexico

**Belarus** siehe/see Ukraine

**Belgium** Rohde & Schwarz Belgium N.V.  
Excelsiorlaan 31 Bus 1  
1930 Zaventem

(Tel) +32 (2) 721 50 02  
(Fax) +32 (2) 725 09 36  
info@rsb.rohde-schwarz.com

**Belize** siehe / see Mexico

**Bermuda** siehe/see Mexico

**Bosnia-Herzegovina** siehe/see Slovenia

**Brazil** Rohde & Schwarz Do Brasil Ltda.  
Av. Alfredo Egidio de Souza Aranha (Bd. Aranha)  
1° andar - Santo Amaro  
04726-170 Sao Paulo - SP

(Tel) +55 (11) 56 44 86 11  
(Fax) +55 (11) 56 44 86 25 (sales)  
(Fax) +55 (11) 56 44 86 36  
sales-brazil@rsdb.rohde-schwarz.com

**Brunei** George Keen Lee Equipment Pte Ltd.  
#11-01 BP Tower  
396 Alexandra Road  
Singapore 119954

(Tel) +656 276 06 26  
(Fax) +656 276 06 29  
gkleqpt@singnet.com.sg

**Bulgaria** Rohde & Schwarz  
Representation Office Bulgaria  
39, Fridtjof Nansen Blvd.  
1000 Sofia

(Tel) +359 (2) 96 343 34  
(Fax) +359 (2) 963 21 97  
rs-bulgaria@rsbg.rohde-schwarz

**Canada** Rohde & Schwarz Canada Inc.  
555 March Rd.  
Kanata, Ontario K2K 2M5

(Tel) +1 (613) 592 80 00  
(Fax) +1 (613) 592 80 09  
sales@rscanada.ca

**Chile** Dymeq Ltda.  
Av. Larrain 6666  
Santiago

(Tel) +56 (2) 339 20 00  
(Fax) +56 (2) 339 20 10  
dymeq@dymeq.com

**China** Rohde & Schwarz China Ltd.  
Representative Office Beijing  
6F, Parkview Center  
2 Jiangtai Road  
Chao Yang District  
Beijing 100016

(Tel) +86 (10) 64 31 28 28  
(Fax) +86 (10) 64 37 98 88  
info.rschina@rsbp.rohde-schwarz.com

Rohde & Schwarz China Ltd.  
Representative Office Shanghai  
Room 807-809, Central Plaza  
227 Huangpi North Road  
Shanghai 200003

(Tel) +86 (21) 63 75 00 18  
(Fax) +86 (21) 63 75 91 70  
May.Zhu@rsbp.rohde-schwarz.com

Rohde & Schwarz China Ltd.  
Representative Office Guangzhou  
Room 2903, Metro Plaza  
183 Tian He North Road  
Guangzhou 510075

(Tel) +86 (20) 87 55 47 58  
(Fax) +86 (20) 87 55 47 59  
Winnie.Lin@rsbp.rohde-schwarz.com

# Adressen/Addresses

<b>China</b>	Rohde & Schwarz China Ltd. Representative Office Chengdu Unit G, 28/F, First City Plaza 308 Shuncheng Avenue Chengdu 610017	(Tel) +86 (28) 86 52 76 06 (Fax) +86 (28) 86 52 76 10 sophia.chen@rsbp.rohde- schwarz.com	<b>Germany</b>	Zweigniederlassung Büro Bonn Josef-Wirmer-Straße 1-3 · D-53123 Bonn Postfach 140264 · D-53057 Bonn	(Tel) +49 (228) 918 90-0 (Fax) +49 (228) 25 50 87 info.rsv@rohde-schwarz.com	
	Rohde & Schwarz China Ltd. Representative Office Xian Room 603, Jin Xin International No. 99 Heping Road Xian 710001	(Tel) +86 (29) 87 41 53 77 (Fax) +86 (29) 87 20 65 00 sherry.yu@rsbp.rohde-schwarz.com		Zweigniederlassung Nord, Geschäftsstelle Hamburg Vierenkamp 6 D-22423 Hamburg	(Tel) +49 (40) 38 61 83 - 00 (Fax) +49 (40) 38 61 83 - 20 info.rsv@rohde-schwarz.com	
	Rohde & Schwarz China Ltd. Representative Office Shenzhen Room 1901, Central Business Building No. 88 Fuhua Yilu Futian District Shenzhen 518026	(Tel) +86 (755) 82 03 11 98 (Fax) +86 (755) 82 03 30 70 jessica.lia@rsbp.rohde-schwarz.com		Zweigniederlassung Mitte, Geschäftsstelle Köln Niederlasser Straße 33 · D-51147 Köln Postfach 900 149 · D-51111 Köln	(Tel) +49 (2203) 807-0 (Fax) +49 (2203) 807-650 info.rsv@rohde-schwarz.com	
<b>Costa Rica</b>	siehe / see Mexico			Zweigniederlassung Süd, Geschäftsstelle München Mühlhildstraße 15 · D-81671 München Postfach 80 14 69 · D-81614 München	(Tel) +49 (89) 41 86 95-0 (Fax) +49 (89) 40 47 64 info.rsv@rohde-schwarz.com	
<b>Croatia</b>	siehe/see Slovenia			Zweigniederlassung Süd, Geschäftsstelle Nürnberg Donaustraße 36 D-90451 Nürnberg	(Tel) +49 (911) 642 03-0 (Fax) +49 (911) 642 03-33 info.rsv@rohde-schwarz.com	
<b>Cuba</b>	siehe / see Mexico			Zweigniederlassung Mitte, Geschäftsstelle Neu-Isenburg Siemensstraße 20 D-63263 Neu-Isenburg Postfach 16 51 D-63236 Neu-Isenburg	(Tel) +49 (6102) 20 07-0 (Fax) +49 (6102) 20 07 12 info.rsv@rohde-schwarz.com	
<b>Cyprus</b>	Hinis Telecast Ltd. Agiou Thoma 18 Kiti Larnaca 7550	(Tel) +357 (24) 42 51 78 (Fax) +357 (24) 42 46 21 hinis@logos.cy.net		<b>Ghana</b>	Kop Engineering Ltd. P.O. Box 11012 3rd Floor Akai House, Osu Accra North	(Tel) +233 (21) 77 89 13 (Fax) +233 (21) 701 06 20 joblink@ghana.com
<b>Czech Republic</b>	Rohde & Schwarz Praha, s.r.o. Hadovka Office Park Evropská 2590/33c 16000 Praha 6	(Tel) +420 (2) 24 31 12 32 (Fax) +420 (2) 24 31 70 43 office@rscz.rohde-schwarz.com		<b>Greece</b>	Mercury S.A. 6, Loukianou Str. 10675 Athens	(Tel) +302 (10) 722 92 13 (Fax) +302 (10) 721 51 98 mercury@hol.gr
<b>Denmark</b>	Rohde & Schwarz Danmark A/S Ejby Industrivej 40 2600 Glostrup	(Tel) +45 (43) 43 66 99 (Fax) +45 (43) 43 77 44 rsdk@rsdk.rohde-schwarz.com		<b>Guatemala</b>	siehe/see Mexico	
<b>Egypt</b>	U.A.S. Universal Advanced Systems 31 Manshiet El-Bakry Street Heliopolis 11341 Cairo	(Tel) +20 (2) 455 67 44 (Fax) +20 (2) 256 17 40 an_uas@link.net		<b>Guiana</b>	siehe / see Mexico	
<b>El Salvador</b>	siehe/see Mexico			<b>Haiti</b>	siehe / see Mexico	
<b>Estonia</b>	Rohde & Schwarz Danmark A/S Estonian Branch Office Narva mnt. 13 10151 Tallinn	(Tel) +372 (6) 14 31 23 (Fax) +372 (6) 14 31 21 estonia@rsdk.rohde-schwarz.com		<b>Honduras</b>	siehe/see Mexico	
<b>Finland</b>	Rohde & Schwarz Finland Oy Taivaltie 5 01610 Vantaa	(Tel) +358 (207) 60 04 00 (Fax) +358 (207) 60 04 17 info@rsfin.rohde-schwarz.com		<b>Hong Kong</b>	Electronic Scientific Engineering 9/F North Somerset House Taikoo Place 979 King's Road, Quarry Bay Hong Kong	(Tel) +852 (25) 07 03 33 (Fax) +852 (25) 07 09 25 stephenchau@ese.com.hk
<b>France</b>	Rohde & Schwarz France Immeuble "Le Newton" 9-11, rue Jeanne Braconnier 92366 Meudon La Forêt Cédex	(Tel) +33 (0) 141 36 10 00 (Fax) +33 (0) 141 36 11 11 contact@rsf.rohde-schwarz.com		<b>Hungary</b>	Rohde & Schwarz Budapesti Iroda Váci út 169 1138 Budapest	(Tel) +36 (1) 412 44 60 (Fax) +36 (1) 412 44 61 rs-hungary@rshu.rohde- schwarz.com
	Niederlassung/Subsidiary Rennes 37 Rue du Bignon Bâtiment A 35510 Cesson Sévigné	(Tel) +33 (2) 99 51 97 00 (Fax) +33 (2) 99 51 98 77		<b>Iceland</b>	siehe/see Denmark	
<b>Germany</b>	Zweigniederlassungen der Rohde & Schwarz Vertriebs-GmbH/Branch offices of Rohde & Schwarz Vertriebs-GmbH			<b>India</b>	Rohde & Schwarz India Pvt. Ltd. 244, Okhla Industrial Estate Phase - III New Delhi 110 020	(Tel) +91 (11) 26 32 63 81 (Fax) +91 (11) 26 32 63 73 sales@rsindia.rohde-schwarz.com
	Zweigniederlassung Nord, Geschäftsstelle Berlin Ernst-Reuter-Platz 10 · D-10587 Berlin Postfach 100620 · D-10566 Berlin	(Tel) +49 (30) 34 79 48-0 (Fax) +49 (30) 34 79 48 48 info.rsv@rohde-schwarz.com			Rohde & Schwarz India Pvt. Ltd. Bangalore Office No. 24, Service Road, Domlur 2nd Stage Extension Bangalore - 560 071	(Tel) +91 (80) 535 23 62 (Fax) +91 (80) 535 03 61 rsindiab@rsnl.net
					Rohde & Schwarz India Pvt. Ltd. Hyderabad Office 302 & 303, Millennium Centre 6-3-1099/1100, Somajiguda Hyderabad - 500 016	(Tel) +91 (40) 23 32 24 16 (Fax) +91 (40) 23 32 27 32 rsindiah@nd2.dot.net.in

# Adressen/Addresses

<b>India</b>	Rohde & Schwarz India Pvt. Ltd. Mumbai Office B-603, Remi Bizcourt, Shah Industrial Estate, Off Veera Desai Road Andheri West Mumbai - 400 058	(Tel) +91 (22) 26 30 18 10 (Fax) +91 (22) 26 73 20 81 rsindiam@rsnl.net	<b>Kazakhstan</b>	Rohde & Schwarz Kazakhstan Representative Office Almaty Pl. Respubliki 15 480013 Almaty	(Tel) +7 (32) 72 67 23 54 (Fax) +7 (32) 72 67 23 46 rs-kazakhstan@rsd-rohde-schwarz.com
<b>Indonesia</b>	PT Rohde & Schwarz Indonesia Graha Paramita 5th Floor Jln. Denpasar Raya Blok D-2 Jakarta 12940	(Tel) +62 (21) 252 36 08 (Fax) +62 (21) 252 36 07 sales@rsbj.rohde-schwarz.com-services@rsbj.rohde-schwarz.com	<b>Kenya</b>	Excel Enterprises Ltd Dunga Road P.O.Box 42 788 Nairobi	(Tel) +254 (2) 55 80 88 (Fax) +254 (2) 54 46 79
<b>Iran</b>	Rohde & Schwarz Iran Liaison Office Tehran Groundfloor No. 1, 14th Street Khaled Eslamboli (Vozara) Ave. 15117 Tehran	(Tel) +98 (21) 872 42 96 (Fax) +98 (21) 871 90 12 alfred.korff@rsd.rohde-schwarz.com	<b>Korea</b>	Rohde & Schwarz Korea Ltd. 83-29 Nonhyun-Dong, Kangnam-Ku  Seoul 135-010	(Tel) +82 (2) 34 85 19 00 (Fax) +82 (2) 547 43 00 sales@rskor.rohde-schwarz.com-service@rskor.rohde-schwarz.com
<b>Ireland</b>	siehe/see United Kingdom		<b>Kuwait</b>	Group Five Trading & Contracting Co. Mezzanine Floor Al-Bana Towers Ahmad Al Jaber Street Sharq	(Tel) +965 (244) 91 72/73/74 (Fax) +965 (244) 95 28 jk_agarwal@yahoo.com
<b>Israel</b>	Eastronics Ltd. Measurement Products 11 Rozanis St. P.O.Box 39300 Tel Aviv 61392	(Tel) +972 (3) 645 87 77 (Fax) +972 (3) 645 86 66 david_hasky@easx.co.il	<b>Latvia</b>	Rohde & Schwarz Danmark A/S Latvian Branch Office Merkela iela 21-301 1050 Riga	(Tel) +371 (7) 50 23 55 (Fax) +371 (7) 50 23 60 latvia@rsdk.rohde-schwarz.com
	J.M. Moss (Engineering) Ltd. Communications Products 9 Oded Street P.O.Box 967 52109 Ramat Gan	(Tel) +972 (3) 631 20 57 (Fax) +972 (3) 631 40 58 jmoss@zahav.net.il	<b>Lebanon</b>	Rohde & Schwarz Liaison Office Riyadh P.O.Box 361 Riyadh 11411	(Tel) +966 (1) 465 64 28 Ext. 303 (Fax) +966 (1) 465 64 28 Ext. 229 chris.porzky@rsd.rohde-schwarz.com
<b>Italy</b>	Rohde & Schwarz Italia S.p.a. Centro Direzionale Lombardo Via Roma 108 20060 Cassina de Pecchi (MI)	(Tel) +39 (02) 95 70 41 (Fax) +39 (02) 95 30 27 72 rsi.info@rsi.rohde-schwarz.com		Netcom P.O.Box 55199 Op. Ex-Presidential Palace Horch Tabet Beirut	(Tel) +961 (1) 48 69 99 (Fax) +961 (1) 49 05 11 tohme.sayar@netcomm.tv
	Rohde & Schwarz Italia S.p.a. Via Tiburtina 1182 00156 Roma	(Tel) +39 (06) 41 59 81 (Fax) +39 (06) 41 59 82 70 rsi.info@rsi.rohde-schwarz.com	<b>Liechtenstein</b>	siehe/see Switzerland	
<b>Jamaica</b>	siehe / see Mexico		<b>Lithuania</b>	Rohde & Schwarz Danmark A/S Lithuanian Branch Office Lukiskiu 5-228 2600 Vilnius	(Tel) +370 (5) 239 50 10 (Fax) +370 (5) 239 50 11 lithuania@rsdk.rohde-schwarz.com
<b>Japan</b>	Rohde & Schwarz Japan K.K. Tokyo Office 711 Bldg., Room 501 (5th floor) 7-11-18 Nishi-Shinjuku Shinjuku-ku Tokyo 160-0023	(Tel) +81 (3) 59 25 12 88 (Fax) +81 (3) 59 25 12 90 scj.support@rsjp.rohde-schwarz.com	<b>Luxembourg</b>	siehe/see Belgium	
	Rohde & Schwarz Japan K.K. Shin-Yokohama Office KM Daiichi Bldg., 8F 2-13-13 Kouhoku-ku Yokohama-shi Kanagawa 222-0033	(Tel) +81 (4) 54 77 35 70	<b>Macedonia</b>	NETRA Sarski odred 7 1000 Skopje	(Tel) +389 (2) 329 82 30 (Fax) +389 (2) 317 74 88 netra@netra.com.sk
	Rohde & Schwarz Japan K.K. Osaka Office TEK Dai 2 Bldg., 8F 1-13-20 Esaka-shi Suita-shi Osaka-fu 564-0063	(Tel) +81 (6) 63 10 96 51	<b>Malaysia</b>	Rohde & Schwarz Malaysia Sdn Bhd Suite 10.04, Level 10, Wisma E&C No. 2 Lorong Dungun Kiri Damansara Heights 50490 Kuala-Lumpur	(Tel) +60 (3) 20 94 00 33 (Fax) +60 (3) 20 94 24 33 sales.malaysia@rohde-schwarz.com
<b>Jordan</b>	Jordan Crown Engineering & Trading Co. Jabal Amman, Second Circle Youssef Ezzideen Street P.O.Box 830414 Amman, 11183	(Tel) +962 (6) 462 17 29 (Fax) +962 (6) 465 96 72 jocrown@go.com.jo	<b>Malta</b>	Tektraco International Technology Ltd. 121, B'Kara Road San Gwann SGN 08	(Tel) +356 (21) 37 43 00 or 37 80 88 (Fax) +356 (21) 37 66 67 sales@tektraco.com
			<b>Mexico</b>	Rohde & Schwarz de Mexico S. de R.L. de C.V. German Centre Oficina 4-2-2 Av. Santa Fé 170 Col. Lomas de Santa Fé 01210 Mexico D.F.	(Tel) +52 (55) 85 03 99 13 (Fax) +52 (55) 85 03 99 16 latinoamerica@rsd-rohde-schwarz.com
			<b>Moldava</b>	siehe/see Austria	
			<b>Nepal</b>	ICTC Pvt. Ltd. Hattisar, Post Box No. 660 Kathmandu	(Tel) +977 (1) 443 48 95 (Fax) +977 (1) 443 49 37 ictc@mos.com.np

# Adressen/Addresses

<b>Netherlands</b>	Rohde & Schwarz Nederland B.V. Perkinsbaan 1 3439 ND Nieuwegein	(Tel) +31 (30) 600 17 00 (Fax) +31 (30) 600 17 99 info@rsn.rohde-schwarz.com	<b>Saudi Arabia</b>	Gentec Haji Abdullah Alireza & Co. Ltd. P.O.Box 43054 Riyadh	(Tel) +966 (1) 293 20 35 (Fax) +966 (1) 466 16 57 akanbar@gentec.com.sa
<b>New Zealand</b>	Nichecom 1 Lincoln Ave. Tawa, Wellington	(Tel) +64 (4) 232 32 33 (Fax) +64 (4) 232 32 30 rob@nichecom.co.nz	<b>Serbia-Montenegro</b>	Rohde & Schwarz Representative Office Belgrade Tose Jovanovica 7 11030 Beograd	(Tel) +381 (11) 305 50 25 (Fax) +381 (11) 305 50 24 rs-scg@rscs.rohde-schwarz.com
<b>Nicaragua</b>	siehe/see Mexico		<b>Singapore</b>	Rohde & Schwarz Regional Headquarters Singapore Pte. Ltd. 1 Kaki Bukit View #05-01/02 Techview Singapore 415 941	(Tel) +65 68 46 18 72 (Fax) +65 68 46 12 52
<b>Nigeria</b>	Ferrostaal Abuja Plot 3323, Barada Close P.O.Box 8513, Wuse Off Amazon Street Maitama, Abuja	(Tel) +234 (9) 413 52 51 (Fax) +234 (9) 413 52 50 fsabuja@rosecom.net			
<b>Norway</b>	Rohde & Schwarz Norge AS Enebakkeveien 302 B 1188 Oslo	(Tel) +47 (23) 38 66 00 (Fax) +47 (23) 38 66 01 firmapost@rsnor.rohde-schwarz.com		Rohde & Schwarz Systems & Communications Asia Pte Ltd Service 1 Kaki Bukit View #04-01/07 Techview Singapore 415 941	(Tel) +65 68 46 37 10 (Fax) +65 68 46 00 29 info@rssg.rohde-schwarz.com
<b>Oman</b>	Mustafa Sultan Science & Industry Co.LLC. Test & Measurement Products Way No. 3503 Building No. 241 Postal Code 112 Al Khuwair, Muscat	(Tel) +968 63 60 00 (Fax) +968 60 70 66 m-aziz@mustafasultan.com	<b>Slovak Republic</b>	Specialne systémy a software, a.s. Svrčia ul. 3 841 04 Bratislava 4	(Tel) +421 (2) 65 42 24 88 (Fax) +421 (2) 65 42 07 68 3s@special.sk
<b>Pakistan</b>	Siemens Pakistan 23, West Jinnah Avenue Islamabad	(Tel) +92 (51) 227 22 00 (Fax) +92 (51) 227 54 98 reza.bokhary@siemens.com.pk	<b>Slovenia</b>	Rohde & Schwarz Representative Office Ljubljana Tbilisjska 89 1000 Ljubljana	(Tel) +386 (1) 423 46 51 (Fax) +386 (1) 423 46 11 rs-slovenia@rssi.rohde-schwarz.com
<b>Panama</b>	siehe/see Mexico		<b>South Africa</b>	Protea Data Systems (Pty.) Ltd. Communications and Measurement Division Private Bag X19 Bramley 2018	(Tel) +27 (11) 719 57 00 (Fax) +27 (11) 786 58 91 unicm@protea.co.za
<b>Papua New Guinea</b>	siehe/see Australia				
<b>Paraguay</b>	siehe/see Argentina				
<b>Philippines</b>	Rohde & Schwarz (Philippines) Inc. Unit 2301, PBCOM Tower 6795, Ayala Ave. cor. Herrera St. Makati City	(Tel) +63 (2) 753 14 44 (Fax) +63 (2) 753 14 56		Protea Data Systems (Pty.) Ltd. Cape Town Branch Unit G9, Centurion Business Park Bosmandam Road Milnerton Cape Town, 7441	(Tel) +27 (21) 555 36 32 (Fax) +27 (21) 555 42 67 unicm@protea.co.za
<b>Poland</b>	Rohde & Schwarz SP.z o.o. Przedstawicielstwo w Polsce ul. Stawki 2, Pietro 28 00-193 Warszawa	(Tel) +48 (22) 860 64 94 (Fax) +48 (22) 860 64 99 rs-poland@rspl.rohde-schwarz.com	<b>Spain</b>	Rohde & Schwarz Espana S.A. Salcedo, 11 28034 Madrid	(Tel) +34 (91) 334 10 70 (Fax) +34 (91) 729 05 06 rses@rses.rohde-schwarz.com
<b>Portugal</b>	Rohde & Schwarz Portugal, Lda. Alameda Antonio Sergio 7-R/C - Sala A 2795-023 Linda-a-Velha	(Tel) +351 (21) 415 57 00 (Fax) +351 (21) 415 57 10 info@rspt.rohde-schwarz.com		Rohde & Schwarz Espana S.A. Av. Príncipe d'Astúries, 66 08012 Barcelona	(Tel) +34 (93) 415 15 68 (Fax) +34 (93) 237 49 95 bcn@rses.rohde-schwarz.com
<b>Republic Dominican</b>	siehe/see Mexico		<b>Sri Lanka</b>	Dynatel Communications (PTE) Ltd. 451/A Kandy Road Kelaniya	(Tel) +94 (112) 90 80 01 (Fax) +94 (112) 91 04 69 69 dynatel@dyanet.lk
<b>Romania</b>	Rohde & Schwarz Representation Office Bucharest 89 Eroii Sanitari Blvd., sector 5 050472 Bucuresti	(Tel) +40 (21) 411 20 13 (Fax) +40 (21) 410 68 46 rs-romania@rsro.rohde-schwarz.com	<b>Sudan</b>	SolarMan Co. Ltd. P.O.Box 11 545 North of Fraouq Cementry 6/7/9 Bldg. 16 Karthoum	(Tel) +249 (183) 47 31 08 (Fax) +249 (183) 47 31 38 solarman29@hotmail.com
<b>Russian Federation</b>	Rohde & Schwarz International GmbH 119180, Yakimanskaya nab., 2 Moscow	(Tel) +7 (095) 745 88 50 to 53 (Fax) +7 (095) 745 88 54 rs-russia@rsru.rohde-schwarz.com	<b>Sweden</b>	Rohde & Schwarz Sverige AB Flygfältsgatan 15 128 30 Skarpnäck	(Tel) +46 (8) 605 19 00 (Fax) +46 (8) 605 19 80 info@rss.rohde-schwarz.com
<b>Saudi Arabia</b>	Rohde & Schwarz International GmbH - Liaison Office Riyadh c/o Haji Abdullah Alireza Co. Ltd. P.O.Box 361 Riyadh 11411	(Tel) +966 (1) 293 2035 (Fax) +966 (1) 466 1657 chris.porzky@rsd.rohde-schwarz.com	<b>Switzerland</b>	Roschi Rohde & Schwarz AG Mühlestr. 7 3063 Ittigen	(Tel) +41 (31) 922 15 22 (Fax) +41 (31) 921 81 01 support@roschi.rohde-schwarz.com
			<b>Syria</b>	Electro Scientific Office Baghdad Street Dawara Clinical Lab. Bldg P.O.Box 8162 Damascus	(Tel) +963 (11) 231 59 74 (Fax) +963 (11) 231 88 75 memo@hamshointl.com



# Adressen/Addresses

<b>Taiwan</b>	Rohde & Schwarz Taiwan (Pvt.) Ltd. Floor 14, No. 13, Sec. 2, Pei-Tou Road Taipei 112	(Tel) +886 (2) 28 93 10 88 (Fax) +886 (2) 28 91 72 60 celine.tu@rstw.rohde-schwarz.com	<b>United Kingdom</b>	Rohde & Schwarz UK Ltd. 3000 Manchester Business Park Aviator Way Manchester M22 5TG	(Tel) +44 (870) 735 16 42 (Fax) +44 (1252) 81 14 77 sales@rsuk.rohde-schwarz.com
<b>Tanzania</b>	SSTL Group P.O. Box 7512 Dunga Street Plot 343/345 Dar Es Salaam	(Tel) +255 (22) 276 00 37 (Fax) +255 (22) 276 02 93 sstl@ud.co.tz	<b>Uruguay</b>	Aeromarine S.A. Cerro Largo 1497 11200 Montevideo	(Tel) +598 (2) 400 39 62 (Fax) +598 (2) 401 85 97 cs@aeromarine.com.uy
<b>Thailand</b>	Rohde & Schwarz International Thailand 2nd floor Gems Tower Bangrak, Suriyawong Bangkok 10600	(Tel) +66 (2) 200 07 29 (Fax) +66 (2) 267 00 79	<b>USA</b>	Rohde & Schwarz, Inc. Eastern Regional Office (US Headquarters) 8661A Robert Fulton Drive Columbia, MD 21046-2265	(Tel) +1 (410) 910 78 00 (Fax) +1 (410) 910 78 01 info@rsa.rohde-schwarz.com
	Schmidt Electronics (Thailand) Ltd. Messtechnik 202 Le Concorede Tower, 23rd Fl. Ratchadaphisek Rd. Huay kwang Bangkok 10320	(Tel) +66 (2) 69 41 47 05 (Fax) +66 (2) 69 41 47 06 salestm@schmidtelectronics.com		Rohde & Schwarz, Inc. Central Regional Office / Systems & EMI Products 8080 Tristar Drive Suite 120 Irving, TX 75063	(Tel) +1 (469) 713 53 00 (Fax) +1 (469) 713 53 01 info@rsa.rohde-schwarz.com
	TPP Operation Co. Ltd. Kommunikationstechnik 41/5 Mooban Tarinee Boromrajchonnee Road Talingchan Bangkok 10170	(Tel) +66 (2) 880 93 47 (Fax) +66 (2) 880 93 47		Rohde & Schwarz, Inc. R&D and Application Support 8905 SW Nimbus Ave Suite 240 Beaverton, OR 97008	(Tel) +1 (503) 403 47 00 (Fax) +1 (503) 403 47 01 info@rsa.rohde-schwarz.com
<b>Trinidad &amp; Tobago</b>	siehe/see Mexico	(Tel) (Fax)		Rohde & Schwarz, Inc. Western Regional Office 7700 Irvine Center Drive Suite 100 Irvine, CA 92618	(Tel) +1 (949) 885 70 00 (Fax) +1 (949) 885 70 01 info@rsa.rohde-schwarz.com
<b>Tunisia</b>	Teletek 71, Rue Alain Savary Residence Alain Savary (C64) Cit� el Khadra 1003 Tunis	(Tel) +216 (71) 77 33 88 (Fax) +216 (71) 77 05 53 teletek@gnet.tn		Rohde & Schwarz, Inc. Service & Calibration Center 8661A Robert Fulton Drive Columbia, MD 21046-2265	(Tel) +1 (410) 910 50 02 (Fax) +1 (410) 910 79 31 service.rsa@rsa.rohde-schwarz.com
<b>Turkey</b>	Rohde & Schwarz International GmbH Liaison Office Istanbul Bagdat Cad. 191/3, Arda Apt. B-Blok 81030 Selamicesme-Istanbul	(Tel) +90 (216) 385 19 17 (Fax) +90 (216) 385 19 18 nadir.guerelman@rsd.rohde-schwarz.com	<b>Vietnam</b>	Rohde & Schwarz Representative Office Vietnam Unit 807, 8/F, Schmidt Tower 239 Xuan Thuy Road Cau Giay District Hanoi	(Tel) +84 (4) 834 20 46
<b>Ukraine</b>	Rohde & Schwarz Representative Office Kiev 4, Patris Loumoumba ul. 01042 Kiev	(Tel) +38 (044) 268 60 55 (Fax) +38 (044) 268 83 64 rsbkiev@public.ua.net	<b>West Indies</b>	siehe/see Mexico	
<b>United Arab Emirates</b>	Rohde & Schwarz International GmbH Liaison Office Middle East Vertrieb P.O. Box 31156 Abu Dhabi	(Tel) +971 (2) 6335 670 (Fax) +971 (2) 6335 671 Dario Barisoni@rsd.rohde-schwarz.com			
	Rohde & Schwarz Bick Mobile Communication P.O.Box 17466 JAFZ, PPU ZG-07 Dubai	(Tel) +971 (4) 883 71 35 (Fax) +971 (4) 883 71 36			
	Rohde & Schwarz Emirates L.L.C. ESNAAD Premisses at Mussafah, P.O.Box 31156 Abu Dhabi	(Tel) +971 (2) 55 49 411 (Fax) +971 (2) 55 49 433 rsuaeam@emirates.net.ae			
<b>United Kingdom</b>	Rohde & Schwarz UK Ltd. Ancells Business Park Fleet Hampshire GU51 2UZ	(Tel) +44 (1252) 81 88 88 (sales)+44 (1252) 81 88 18 (service) (Fax) +44 (1252) 81 14 47 sales@rsuk.rohde-schwarz.com			



# 1 Connecting an External Mixer

To increase the frequency range FSE (models 21/31 or models 20/30 with option FSE-B21) can be operated with external mixers.

Both two-port and three-port mixers can be used. Connect mixer as follows:

**Note:** Use the coaxial cable supplied to feed in the LO signal.  
If no external mixers are connected to FSE, cover the two front connectors 'LO OUT / IF IN' and 'IF IN' with the SMA caps supplied.

## Three-port mixer:

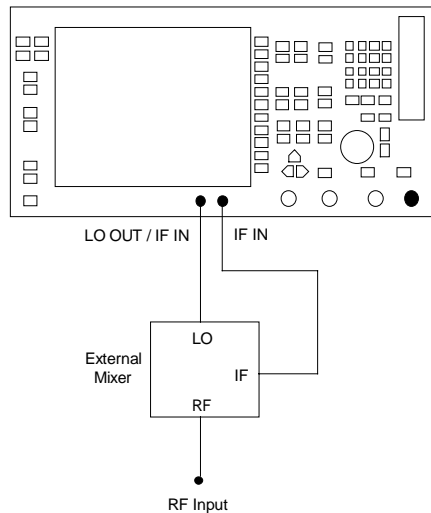

- Connect the 'LO OUT / IF IN' output of FSE to the LO port of the external mixer.
- Connect the 'IF IN' input of FSE to the IF port of the external mixer.
- Feed the signal to be measured to the RF input of the external mixer.

## Two-port mixer:

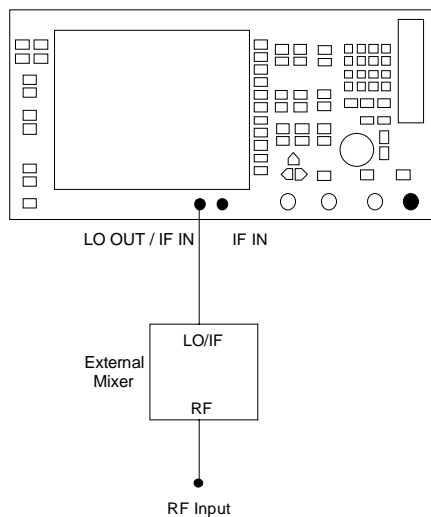

- Connect the 'LO OUT / IF IN' output of FSE to the LO/IF port of the external mixer.  
Because of the diplexer contained in FSE the IF signal can be tapped from the line which is used to feed the LO signal to the mixer.
- Feed the signal to be measured to the RF input of the external mixer.



## 2 Manual Operation

### 2.1 Menu Overview

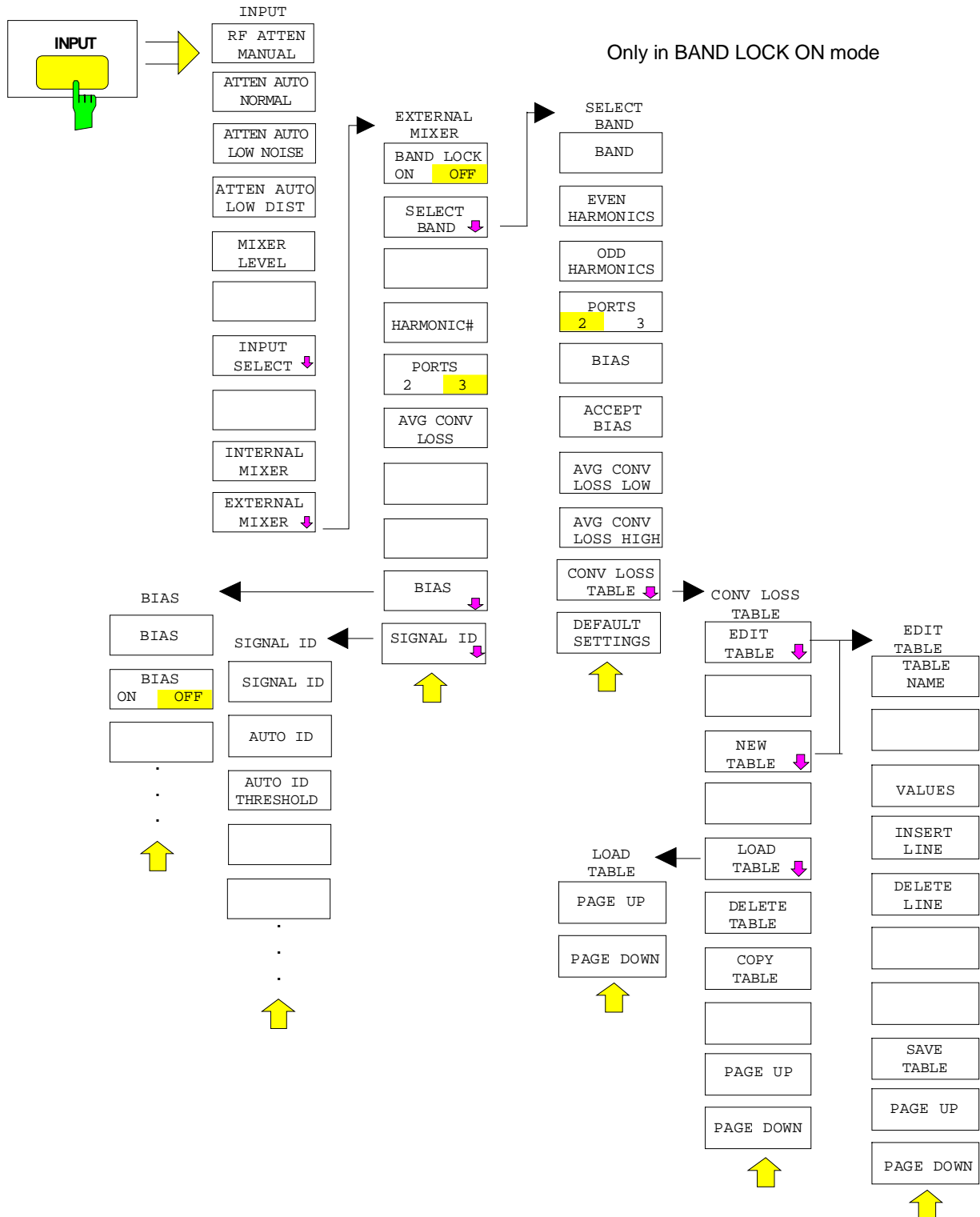

## 2.2 Configuration of the External Mixer - INPUT Key

External mixing can only be called up in the *ANALYZER* mode. If this mode is active, all other operating modes will be disabled. The maximum settable frequency is 531 GHz.

### Frequency range

The frequency of the input signal can be expressed as a function of the LO frequency and the selected harmonic of the 1st LO is as follows:

$$f_{in} = n * f_{LO} + f_{IF}$$

where:  $f_{in}$  frequency of input signal  
 $n$  order of harmonic used for conversion  
 $f_{LO}$  frequency of 1st LO 7.5 to 15.2 GHz  
 $f_{IF}$  intermediate frequency 741.4 MHz

**Note:** *The LO frequency range cannot be used to the full due to the signal identification functions (SIGNAL ID and AUTO ID, see section 2.2.4)*

### Full-screen level

The maximum settable reference level depends on the external mixer's conversion loss which is entered on FSE using the softkeys *AVG CONV LOSS* or *CONV LOSS TABLE*.

If an IF signal with a level of -20 dBm is applied to the LO OUT / IF IN or IF IN input of FSE, full screen level will be attained. Consequently, the maximum settable reference level will be -20 dBm at a set conversion loss of 0 dB.

If a conversion loss > 0 dB is entered, the maximum settable reference level increases in the same proportion, ie when an average conversion loss of eg 30 dB is entered a maximum reference level of +10 dBm can be set. Note that full-scale level can be obtained at a level of -20 dBm at the IF input. If a signal with a level of -20 dBm is applied to the IF input, it will be displayed with a level of +10 dBm.

If the maximum possible reference level is set on FSE, this level will be reduced if a smaller conversion loss is entered.

When digital filters are used (IF bandwidths < 1 kHz as well as 1 kHz if '1 kHz digital' is selected) the overload limit is typically approx. 3 dB above the set reference level. IF signals with higher levels cause the A/D converter to be overloaded (display 'IFOVL').

If an analog IF filter is used, the overload limit is determined by the IF amplifier. In this case, the 1 dB compression point is approximately 6 dB above the reference level. Overload display 'OVL' appears at higher levels.

In addition to the dynamic range of the spectrum analyzer the 1 dB compression point of the mixer has to be taken into account. The levels of the input signals should lie well below this value to avoid generation of harmonics of these signals in the mixer. These are converted by the LO signals harmonics of higher order and appear in the displayed spectrum.

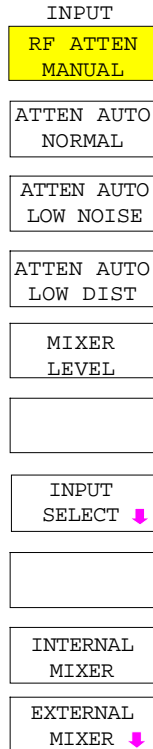
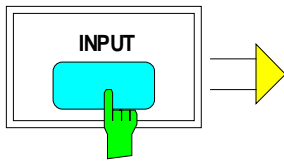

The *INPUT* key calls up the menu for configuring the external mixer and the RF input.

The configuration of the RF input is described in the section "Configuring the RF input - *INPUT* key" of the FSE manual.

The softkeys *INTERNAL MIXER* and *EXTERNAL MIXER* are selector switches only one of which may be active at a time. They indicate the current mode of FSE - normal operation or external mixing.

The *EXTERNAL MIXER* softkey opens up a submenu for setting the parameters of the external mixer.



The *INTERNAL MIXER* softkey switches to normal operation (internal mixer).

*INTERNAL MIXER* is the default setting.

INPUT menu:

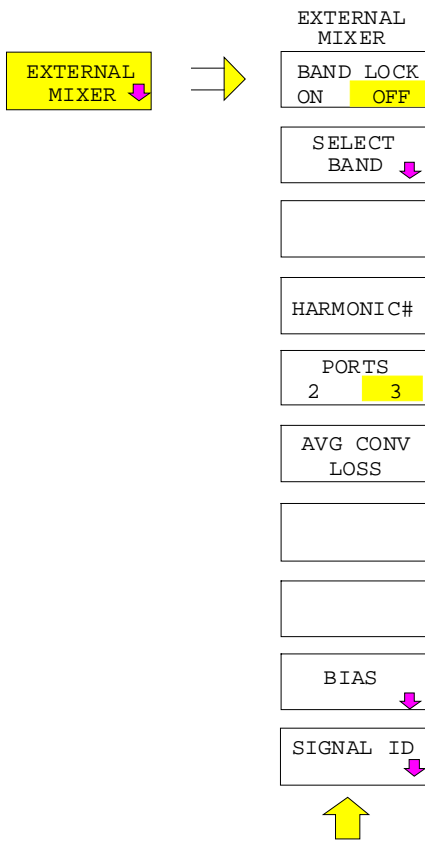

The *EXTERNAL MIXER* softkey opens up a submenu for setting the parameters of the external mixer. The softkey automatically switches on the external mixer.

The mode selected by means of the *BAND LOCK ON/OFF* softkey is activated. The submenu displayed changes accordingly.

*BAND LOCK ON* The *SELECT BAND* softkey can be operated.

*BAND LOCK OFF* The *HARMONIC#*, *PORTS 2/3* and *AVG CONV LOSS* softkeys can be operated.

Settings for bias and signal identification in both modes are made in the *BIAS* and *SIGNAL ID* submenus.



The *BAND LOCK ON/OFF* softkey switches between the *BAND LOCK ON* and *BAND LOCK OFF* mode.

*BAND LOCK ON* The settable frequency range is determined by a waveguide band which can be chosen from the *SELECT BAND* table (*SELECT BAND* softkey). The harmonic used for conversion is selected automatically. The table contains user-defined parameters for each waveguide band. This mode enables the easy use of the external mixer since changing the waveguide band automatically sets all parameters (see following section "*BAND LOCK ON* Mode").

*BAND LOCK OFF* The user can choose the settable frequency range or the order of the harmonic used for conversion. This means that all parameters can be user-defined (see following section "*BAND LOCK OFF* Mode").



### 2.2.1 BAND LOCK ON Mode

In the *BAND LOCK ON* mode, the settable frequency range is determined by the selected waveguide band. It is possible to exceed the upper and lower limits of the frequency band, an absolute limit being given by the harmonic used for conversion in the selected waveguide band. A warning (Ovrangle) is output when waveguide band limits are exceeded.

#### 2.2.1.1 Selecting a Waveguide Band and Setting the Parameters

The *SELECT BAND* softkey opens up a submenu for selecting the waveguide band and for setting all necessary parameters. The harmonic to be used for conversion is selected automatically.

*INPUT EXTERNAL MIXER* menu (*BAND LOCK ON*)

SELECT BAND								
BAND	RANGE/GHz	HARMONIC#	EVEN/ODD HARMONICS	PORTS	BIAS /mA	AVG CONV LOSS/dB LOW	HIGH	CONV LOSS TABLE
A	26.5 - 40	2 / 4	even	2	0.00	17.0	19.0	
Q	33 - 50	4	even	2	0.00			RS_BND_Q
U	40 - 60	4	even	2	0.00	21.0		
V	50 - 75	5	odd	3	0.00	23.0		
E	60 - 90	6	even	2	0.00			RS_BND_E
W	75 - 110	8	even	2	0.00			RS_BND_W
F	90 - 140	10	even	2	5.00	38.0		
D	110 - 170	12	even/odd	2	7.00			RS_BND_D
✓ G	140 - 220	16	even	2	10.00	52.5		
Y	170 - 260	18	even	3	9.00	55.0		
J	220 - 330	22	even	2	10.00			RS_BND_J

USER

SELECT BAND

BAND

EVEN HARMONICS

ODD HARMONICS

PORTS 2 3

BIAS

ACCEPT BIAS

AVG CONV LOSS LOW

AVG CONV LOSS HIGH

CONV LOSS TABLE

DEFAULT SETTINGS

The table contains the following parameters for each band:

<i>Band</i>	Designation of waveguide band
<i>Range</i>	Frequency range
<i>Harmonic#</i>	Order of harmonic used for conversion. The order is selected automatically depending on the definition made in the <i>EVEN / ODD HARMONICS</i> column. The lowest order is selected that allows conversion of input signals in the whole band.
<i>Even/Odd Harmonics</i>	Defines if only even, only odd, or even and odd harmonics can be used for conversion with the mixer connected.
<i>Ports</i>	Two- or three-port mixer.
<i>Bias</i>	Selected bias current.  <b>Note:</b> <i>The current corresponds to the short-circuit current. The actual bias current is lower because of the forward voltage of the mixer diode(s).</i>
<i>AVG Conv Loss</i>	Average conversion loss of external mixer. The value is used for calculating the input level.
<i>Conv Loss Table</i>	Alternatively to the average value stated under <i>AVG Conv Loss</i> , conversion loss can be taken into account as a function of frequency. The <i>Conv Loss Table</i> field gives the name (without extension) of a binary file stored on the harddisk. The file contains the following data of the associated mixer: <ul style="list-style-type: none"> <li>- type designation of mixer</li> <li>- serial No. of mixer</li> <li>- waveguide band</li> <li>- even / odd harmonics</li> <li>- number of ports (2 / 3)</li> <li>- bias current</li> <li>- conversion loss as a function of the frequency with which the level of the input signal is calculated.</li> </ul>

Modified parameters will be immediately active. Table contents are not changed by preset or warm start. Use the *DEFAULT SETTINGS* softkey to reset the unit to the preset values.

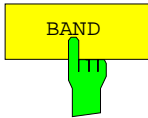

The *BAND* softkey opens up a selection list with the available waveguide bands. The selected band is marked in the *Band* column and the associated frequency range indicated in the *Range/GHz* column.

BAND		
A	26.5	- 40
Q	33	- 50
✓ U	40	- 60
V	50	- 75
E	60	- 90
W	75	- 110
F	90	- 140
D	110	- 170
G	140	- 220
Y	170	- 260
J	220	- 330



The *EVEN / ODD HARMONICS* softkeys select the type of harmonics to be used for conversion in the selected waveguide band. Both types of harmonics can be selected.



The selected type of harmonics is indicated in the table by *even*, *odd* or *even&odd*.

The order indicated in the *Harmonic#* column with regard to the harmonic used for conversion is adapted to the even/odd setting.

These softkeys can only be used if *AVG CONV LOSS* (conversion loss taken into account by means of an average value) is active.

If *CONV LOSS TABLE* is active (conversion loss taken into account by means of frequency-dependent values), these softkeys are without effect.

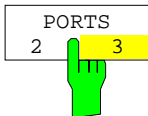

The *PORTS 2/3* softkey is for defining whether the mixer used for the selected band is a two-port or a three-port mixer.

The selected mixer is indicated in the table by 2 or 3.

This softkey can only be used if *AVG CONV LOSS* (conversion loss taken into account by means of an average value) is active.

If *CONV LOSS TABLE* is active (conversion loss taken into account by means of frequency-dependent values), this softkey is without effect.

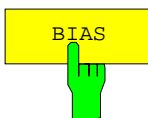

The *BIAS* softkey allows the bias current for the selected band to be entered (see following section "Bias Current").

If *CONV LOSS TABLE* is active, a change of the bias current will be temporary only, ie the changed data will not be stored in the *CONV LOSS TABLE* file. To store the changes press the *ACCEPT BIAS* softkey.

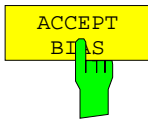

The *ACCEPT BIAS* softkey stores the current bias setting in the file specified in the table.

The user is prompted to confirm the storage. The new setting will be stored only when confirmed with *YES*.

This softkey can only be used if *CONV LOSS TABLE* (conversion loss taken into account by means of frequency-dependent values) is active.



The *AVG CONV LOSS LOW* softkey allows an average value to be entered by means of which the conversion loss is taken into account.

The selected average is indicated in the *AVG CONV LOSS/dB* column of the table.

**Special cases:**

The *AVG CONV LOSS HIGH* softkey can only be used if the following special cases occur when a selection from band A or Q is made:

In band A, with even harmonics selected, switchover must be made between the 2nd and the 4th harmonic to cover the whole band. This applies to band Q analogously where, with odd harmonics selected, switchover must be made between the 3rd and the 5th harmonic.

Since the conversion loss of a mixer depends, among other factors, on harmonic order, FSE offers the possibility of entering two average values for conversion loss to cater for these special cases. With *AVG CONV LOSS LOW*, the average conversion loss for the lower frequency range is entered, with *AVG CONV LOSS HIGH* that for the upper frequency range.

Switchover is made at 29.6 GHz (band A) and 44.0 GHz (band Q). Signals with a frequency of 29.6 GHz or 44.0 GHz are converted using the lower harmonic in each case.

As described above, the maximum settable reference level depends on the conversion loss entered. In the above special cases the upper limit is determined by the lower one of the conversion losses entered by means of *AVG CONV LOSS LOW* or *AVG CONV LOSS HIGH*.



The *CONV LOSS TABLE* softkey allows the conversion loss of the mixer in the selected band to be taken into account as a function of frequency.

The required correction data are taken from a file. For the selected band the *Harmonic#, Even/Odd Harmonics, Ports* and *Bias* columns are filled with the data contained in this file. These columns cannot be edited afterwards.

The *CONV LOSS TABLE* opens up a submenu for selecting and editing the files (see following section "Conversion Loss Taken into Account as a Function of Frequency").

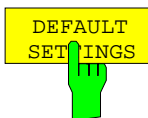

The *DEFAULT SETTINGS* softkey resets the contents of the entire table to the preset values.

If the key is pressed, a window opens in which the user is prompted to confirm or abort the reset.

### 2.2.1.2 Conversion Loss Taken into Account as a Function of Frequency

The *CONV LOSS TABLE* softkey allows the conversion loss of the mixer to be taken into account as a function of frequency. The softkey opens a list from which a file with frequency-dependent conversion loss data for the mixer used can be selected.

INPUT - EXTERNAL MIXER - SELECT BAND submenu (*BAND LOCK ON*)

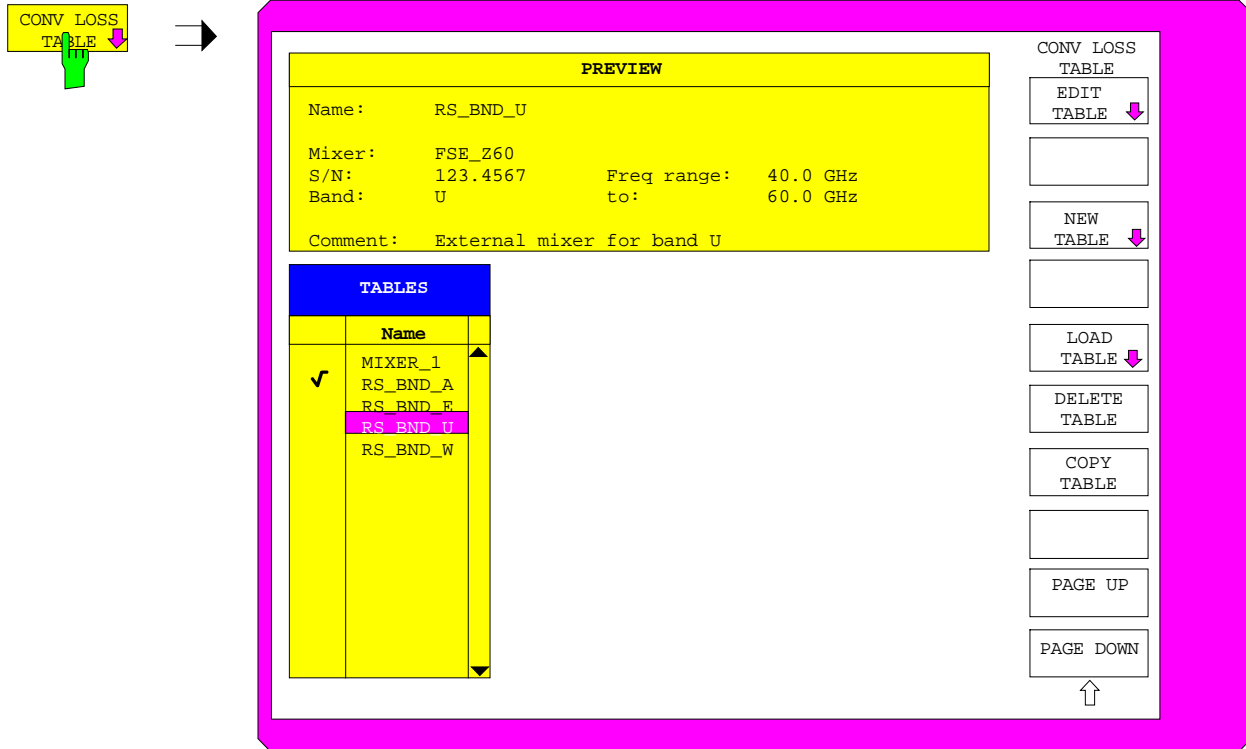

The *PREVIEW* window shows the information characterizing the marked file:

<i>Name</i>	name of marked file
<i>Mixer</i>	type of mixer
<i>S/N</i>	serial No. of mixer
<i>Band</i>	waveguide band
<i>Freq range</i>	frequency range
<i>Comment</i>	comment

The *TABLES* table lists the files stored on the hard disk.

If a file is selected for a band other than the currently active one, an error message is output and the selection must be made anew.

After selection of the file the parameters *Band*, *Even/Odd Harmonics*, *Ports* and *Bias* for the *SELECT BAND* table are taken from the file. It is not possible to modify these parameters during operation.

The maximum settable reference level depends on the reference value which is valid for the table selected and for which the lowest conversion loss is given. Only that part of the table is taken into account which contains reference values for frequencies that are covered by the selected harmonic of order n (see illustration below).

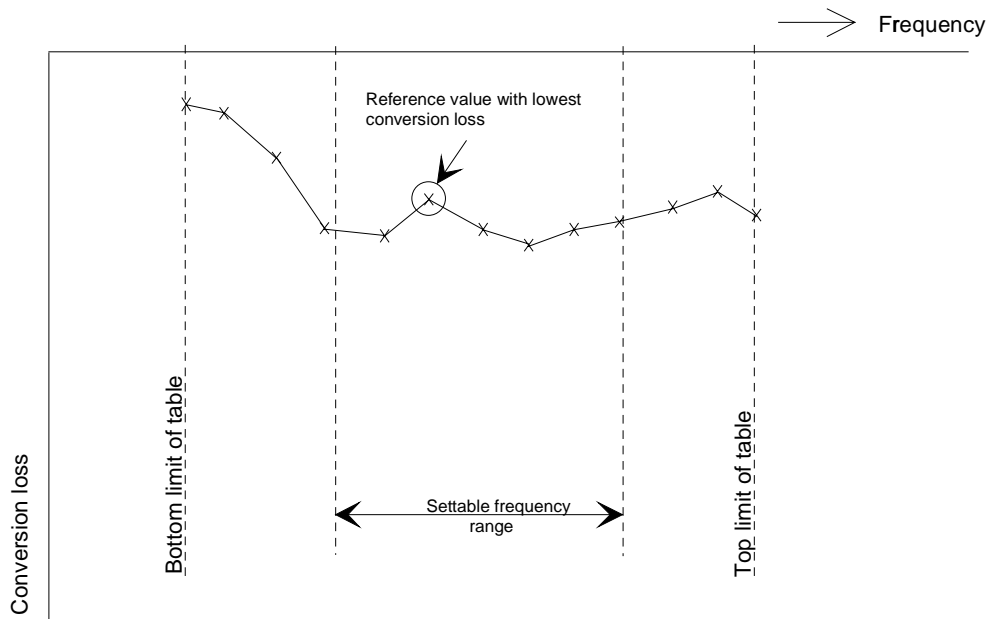
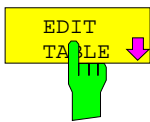
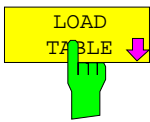
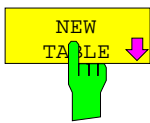

Fig. 2-1: Minimum conversion loss in the settable frequency range



The *EDIT TABLE* or *NEW TABLE* softkey activates a submenu for editing or generating a file (see following section "Editing a Table").



The *LOAD TABLE* softkey opens a submenu with a table *TABLES ON DISK* specifying all files stored on the inserted disk with mixer correction data (extension '.CL'). The file selected is copied onto the harddisk.

TABLES ON DISK	
	Name
✓	RS_BND_A
	RS_BND_E
	RS_BND_U
	RS_BND_W

This function is needed, for example, for the initial loading of correction data of a new mixer from the supplied diskette to the FSE harddisk. See submenu *INPUT - EXTERNAL MIXER - SELECT BAND* for explanation of *PREVIEW* field.



The *DELETE TABLE* softkey deletes the selected file from the harddisk of FSE. If the key is pressed, a window opens in which the user is prompted to confirm or abort deleting.

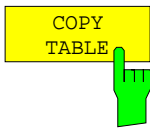

The *COPY TABLE* softkey copies the selected table. The table is stored under another name and can be edited later on.

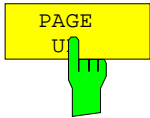

The *PAGE UP/PAGE DOWN* softkeys are used for scrolling through a selection list.

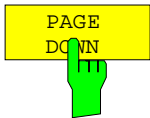

### 2.2.1.2.1 Editing a Table

The *EDIT TABLE* or *NEW TABLE* softkey activates a submenu in which all entries of an existing table can be modified or in which a new table can be generated.

INPUT-EXTERNAL MIXER-SELECT BAND - CONV LOSS TABLE submenu (BAND LOCK ON)

**EDIT CONVERSION LOSS TABLE**

Name: RS\_BND\_U

Mixer: FSE\_Z60  
 S/N: 123.4567      Freq range: 40.0 GHz  
 Band: U                      to: 60.0 GHz

Even/odd: even                      Ports: 2  
 Bias: 0.00 mA

Comment: External mixer for band U

**EDIT CONVERSION LOSS TABLE VALUES**

Frequency	Conv Loss/dB
40.0000 GHz	20.5
41.0000 GHz	20.8
42.0000 GHz	20.9
43.0000 GHz	21.1
44.0000 GHz	21.4
45.0000 GHz	21.7
46.0000 GHz	22.2
47.0000 GHz	22.7
48.0000 GHz	23.1
49.0000 GHz	23.3
50.0000 GHz	23.9
51.0000 GHz	23.2
52.0000 GHz	23.8
53.0000 GHz	24.1

**EDIT TABLE**

**TABLE NAME**

VALUES

INSERT LINE

DELETE LINE

SAVE TABLE

PAGE UP

PAGE DOWN

↑

USER

The following entries can be edited in the *EDIT CONVERSION LOSS TABLE* window:

<i>Name</i>	table name (max. 8 characters), corresponds to file name, the extension ('.CL') is automatically appended on storing
<i>Mixer</i>	type designation of mixer
<i>S/N</i>	serial No. of mixer
<i>Band</i>	designation of waveguide band
<i>Freq range</i>	frequency range
<i>Even/odd</i>	even, odd or even and odd harmonics used for conversion
<i>Ports</i>	two- or three-port mixer
<i>Bias</i>	bias setting
<i>Comment</i>	comment (max. 60 characters)

The *EDIT CONVERSION LOSS TABLE VALUES* table contains a maximum of 50 reference values with frequency (*Frequency*) and conversion loss in dB (*Conv Loss/dB*).

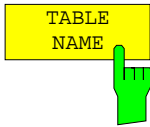

The *TABLE NAME* softkey allows to make entries in the *EDIT CONVERSION LOSS TABLE*. It positions the cursor on the table name field. After an input the cursor automatically jumps to the next entry in the table.

**Name - file name**

The name of the table is identical with the name of the file (without extension) in which the table is stored. The entry in this field is mandatory. The name may consist of a maximum of 8 characters.

**Mixer - type designation of mixer**

The information in the *Mixer* field shows the user at a glance to which mixer a file belongs. Entries in this field are optional.

**S/N - serial No. of mixer**

The information in the *S/N* field shows the user at a glance to which mixer a file belongs. Entries in this field are optional.



**Band - designation of waveguide band**

A waveguide band can be selected from a list. With a selection having been made, the *Freq range* field is automatically filled with the valid frequency limits.

BAND
A
Q
<input checked="" type="checkbox"/> U
V
E
W
F
D
G
Y
J

**Freq range - frequency range**

The *Freq range* field is automatically filled with the frequency limits of the selected band. It cannot be edited.

**Even/odd - selection of harmonics**

A list is displayed from which even, odd, or even and odd harmonics can be selected for conversion. The entry in this field is mandatory.

EVEN/ODD
<input checked="" type="checkbox"/> even
<input type="checkbox"/> odd
<input type="checkbox"/> even&odd

**Ports - two- or three-port mixer**

A list is displayed from which the number of ports (two or three) of the mixer used can be selected. The entry in this field is mandatory.

PORTS
<input checked="" type="checkbox"/> 2
<input type="checkbox"/> 3

**Bias - bias setting**

The bias current required for the mixer has to be entered in this field. The setting range is between -10 mA and +10 mA. The entry in this field is mandatory.

**Note:** *The current corresponds to the short-circuit current. The actual bias current is lower because of the forward voltage of the mixer diode(s).*

**Comment**

The comment can be freely defined by the user. It may consist of a maximum of 60 characters. This field need not necessarily be filled in.

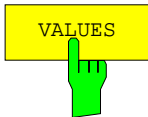

The *VALUES* softkey activates the entry of the reference values into *CONVERSION LOSS TABLE VALUE*.

The reference values must be entered in order of increasing frequencies. A maximum of 50 reference values can be entered.

Correction values for frequencies between the individual reference values are obtained by interpolation. Linear interpolation is performed if the table contains only two values. If it contains more than two reference values, spline interpolation is carried out.

Outside the frequency range covered by the table the conversion loss is assumed to be the same (see illustration below) as that for the reference value marking the table limit.

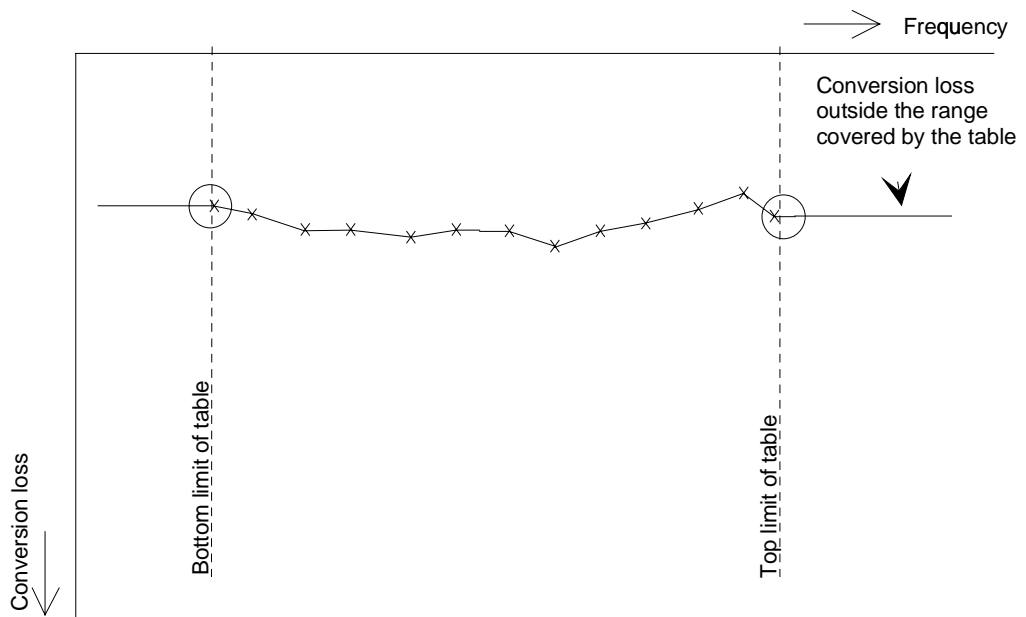
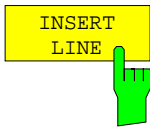
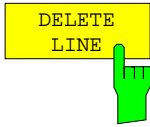

Fig. 2-2: Conversion loss outside the frequency range covered by a table



The *INSERT LINE* softkey inserts a blank line at the cursor position. Subsequent entries are shifted downwards by one line.



The *DELETE LINE* softkey deletes the marked line in the reference value table.

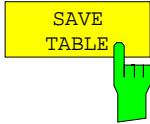

Softkey *SAVE TABLE* stores the edited table on the FSE hard disk under the name given in the field *NAME*. The extension '.CL' is automatically appended to the file name.

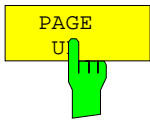

The *PAGE UP* and *PAGE DOWN* softkeys allow to scroll through the selection list.

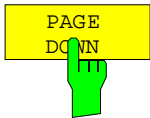

Upon editing a conversion loss table, the data must be stored on the harddisk of FSE.



With *MENU UP*, an edited table can be accepted, checked for consistency with permissible values and stored on harddisk under the specified table name.

The user has to confirm whether he wants to store the table (*YES*) or not (*NO*) or whether storage is to be aborted (*CANCEL*). After storage has been aborted, the table comes up again and the user can continue editing.

MESSAGE		
Do you want to store this table?		
YES	NO	CANCEL

When the file is stored, an extension is added automatically.

If the name of the table to be stored is already used by another file, the user is asked if the old table is to be overwritten. If the user does not wish to overwrite the old file, he can further edit the new table, eg assign it a new name not used so far.

MESSAGE	
File exists! Do you want to overwrite?	
YES	NO

Upon exiting the *EDIT* menu, the table can be activated from the relevant selection list.

### 2.2.2 BAND LOCK OFF Mode

In the *BAND LOCK OFF* mode, the user can define the order of the harmonic used for conversion.

*INPUT EXTERNAL MIXER* menu (*BAND LOCK OFF*)



The *HARMONIC#* softkey opens a window in which the user can define the order *n* of the harmonic used for conversion. Both even and odd harmonics between 2 and 62 can be entered. The selected harmonic, together with the setting range of the 1st LO, determines the limits of the settable frequency range.

The following applies:

Lower frequency limit:  $f_{\min.} = n * f_{LO,\min.} + f_{IF}$

Upper frequency limit:  $f_{\max.} = n * f_{LO,\max.} - f_{IF}$

where	<i>n</i>	order of harmonic	
	$f_{LO,\min}$	lower frequency limit of LO	(7.5 GHz)
	$f_{LO,\max}$	upper frequency limit of LO	(15.2 GHz)
	$f_{IF}$	intermediate frequency	(741.4 MHz)

**Note:** *The equations specified have been modified such that a signal identification is always possible with SIGNAL ID or AUTO ID (see section 2.2.2) within the resulting frequency range.*

For *n* = 35, for example, a frequency maximum of about 531 GHz is obtained.

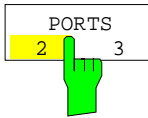

With the *PORTS 2 / 3* softkey the user can enter the type of mixer used, ie two-port or three-port mixer.

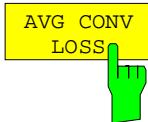

The *AVG CONV LOSS* softkey allows an average value to be entered for the conversion loss. This average value is used for input level calculation throughout the complete frequency range defined by the selected harmonic.

### 2.2.3 Bias Current

Single-diode mixers generally require a DC voltage which is applied via the LO line. This DC voltage is to be tuned to the minimum conversion loss versus frequency. Such a DC voltage can be set in the modes *BAND LOCK ON* and *BAND LOCK OFF* via the *BIAS* function using the D/A converter of FSE. The value to be entered is not the voltage but the short-circuit current. The bias circuit as implemented in FSE is shown in Fig. 2-3.

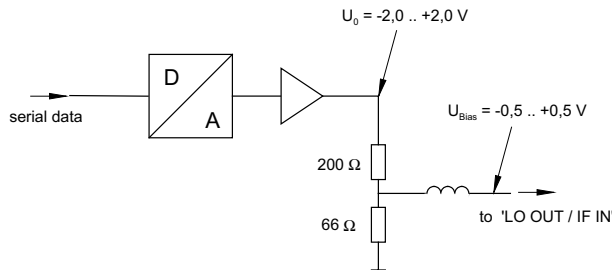
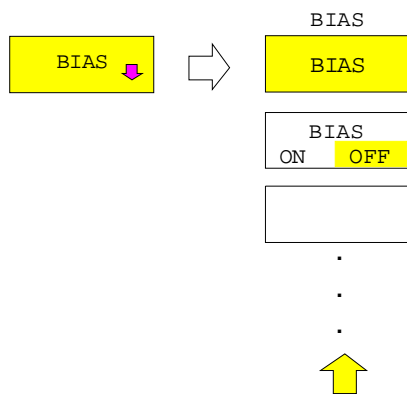

Fig 2-3: Bias circuit of FSE

The voltage  $U_0$  at the output of the operational amplifier can be set in the range  $-2.0$  to  $+2.0$  V. An open-circuit voltage  $V_{bias}$  of  $-0.5$  to  $+0.5$  V is obtained accordingly at the output of the voltage divider. A short-circuit current of  $I_{short} = V_0 / 200 \Omega = -10$  mA to  $+10$  mA is obtained for a short circuit at the output of the voltage divider. For using biasing it is not important to know exactly the current flowing through the diode since the conversion loss must be set to minimum with the frequency. It therefore makes no difference whether the setting is performed by an open-circuit voltage or by a short-circuit current. A DC return path is ensured via the  $66 \Omega$  resistor, which is an advantage in some mixers.

#### INPUT- EXTERNAL MIXER menu



The *BIAS* softkey opens up the submenu for setting the bias current.

This submenu is available both in the *BAND LOCK ON* and the *BAND LOCK OFF* mode.

**BAND LOCK ON** The bias settings for the selected band are entered in the *SELECT BAND* table. With *BIAS OFF* a bias current of  $0.0$  mA is entered in the table. If the *CONV LOSS TABLE* mode is active for the selected band, the modifications are not stored in the file specified for the selected band until the *ACCEPT BIAS* softkey of the *SELECT BAND* submenu is pressed.

**BAND LOCK OFF** The settings are accepted immediately.

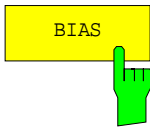

The *BIAS* softkey allows the bias current to be entered. Moreover it switches on the bias current if it had been switched off by means of the *BIAS ON / OFF* softkey.

The setting range is -10 mA to +10 mA.

The current entered is the short-circuit current. The actual bias current is lower because of the forward voltage of the mixer diode.

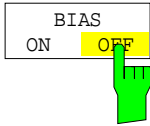

The *BIAS ON / OFF* softkey switches the bias current on or off. If the bias current is switched on again, the value last set is restored.

### 2.2.4 Signal Identification

INPUT- EXTERNAL MIXER menu

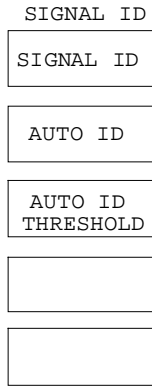

The *SIGNAL ID* softkey opens up the submenu for setting the signal identification.

The softkeys *SIGNAL ID* and *AUTO ID* are selector switches only one of which may be active at a time. However, both functions can be disabled.

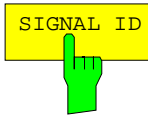

The *SIGNAL ID* softkey activates or deactivates visual signal identification.

Two sweeps are performed alternately. The FSE operates in the split-screen mode, changing to the full-screen mode is not possible.

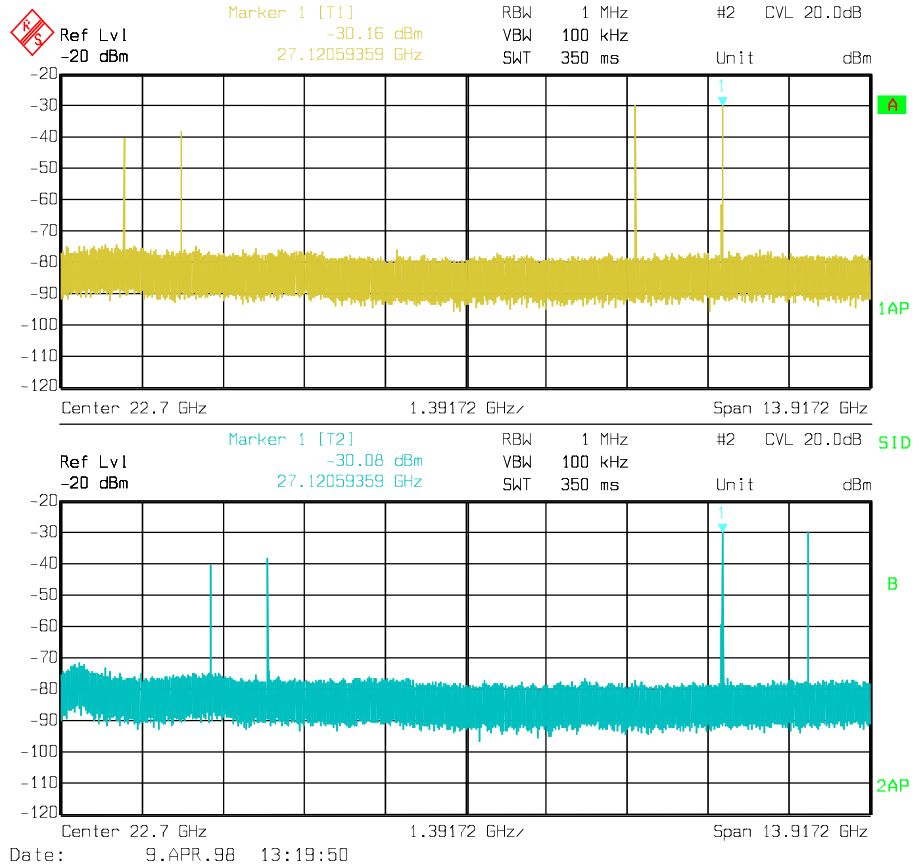



The top window shows the test sweep (trace 1), the bottom window the reference sweep (trace 2).

The reference sweep is performed using a LO setting shifted downwards by  $2 \cdot \text{IF} / \text{Harmonic\#}$ . Input signals in the wanted sideband that are converted by means of the set harmonic are displayed in both windows at the same position on the frequency axis. Image signals and mixer products caused by other harmonics are displayed in both windows at different positions.

The user identifies the signals visually by comparing the two windows.

The same detectors are used for the test sweep and the reference sweep. If the detector is changed in one window, the new detector is automatically activated in the other window as well.

Since the LO frequency is displaced downwards in the reference sweep, the conversion loss of the mixer may differ from the test sweep.

Therefore the level should only be measured in the test sweep (top window).

The spectra displayed in the two windows can be copied into the unused result memories 3 or 4 by means of the *TRACE COPY* function (see section "Selecting and Setting Traces - *TRACE* Keys").

Mathematical functions with traces cannot be used in the *SIGNAL ID* menu.

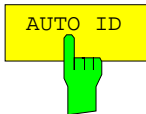

The *AUTO ID* softkey activates or deactivates automatic signal identification.

*AUTO ID* basically functions like *SIGNAL ID*. However, the test and reference sweeps are converted into a single trace by a pixel-by-pixel comparison (500 pixels per sweep) and displayed. Unwanted mixer products are suppressed in this calculated trace.

As described for the function *SIGNAL ID*, real input signals are displayed at the same frequency in the test and reference sweeps, ie theoretically identical signal levels are expected in the two sweeps at the frequency of the real mixer product. If the level difference is lower than the tolerance set with *AUTO ID THRESHOLD*, the signal obtained in the test sweep is displayed.

If a signal occurs only in the test sweep or reference sweep, it is an unwanted mixer product. The level of this signal is compared to the noise floor in the other sweep. If the S/N ratio is sufficiently large, the tolerance limit for the maximum permissible level difference is exceeded. This means that the signal with the lower level, ie noise in this case, is displayed.

It should be noted that *AUTO ID* functions according the fail-safe principle, ie unwanted mixer products may not be detected as such but signals which are in fact real input signals are not blanked out. See also "Remarks concerning Signal Identification with *AUTO ID*".

The function AUTO ID can be called only if screen A is active.

In *AUTO ID* mode, the FSE operates in the full-screen mode, changing to the split-screen mode is not possible.

The trace displayed on the screen can be copied into the unused result memory 3 by means of the *TRACE COPY* function (see section "Selecting and Setting Traces - *TRACE* Keys"). The traces 2 and 4 are not available in this mode.

Mathematical functions with traces and the function *SIGNAL COUNT* cannot be used in the *AUTO ID* menu.

To be able to determine the frequency of an input signal precisely, a marker can be set onto the identified signal. If *AUTO ID* is disabled, calling *SIGNAL COUNT* allows the exact frequency of this signal to be determined.

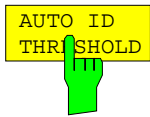

*AUTO ID THRESHOLD* allows the maximum permissible level difference to be fixed between test sweep and reference sweep during automatic comparison (function *AUTO ID*). The input range is between 0.1 dB and 100 dB.

Values of about 10 dB (ie default setting) generally yield satisfactory results. See also "Remarks concerning Signal Identification with AUTO ID".

## Remarks concerning Signal Identification with AUTO ID

### Type of signal

The automatic comparison of the test sweep and reference sweep with *AUTO ID* can be usefully applied only for signals with time-constant spectrum since the two sweeps are always required to determine the actual spectrum.

### Tolerance for the comparison of test sweep and reference

Since the LO frequency is displaced downwards in the reference sweep, the conversion loss of the mixer may differ from that of the test sweep. The reasons for this are the LO output power of the spectrum analyzer varying with the frequency and the non-ideal characteristics of the mixer. A certain tolerance should therefore be permitted for the comparison of the signal levels in the test sweep and reference sweep. The user can set this tolerance on FSE using the function *AUTO ID THRESHOLD*.

If the tolerance set is too tight the signal collected with the reference sweep may be displayed even for the identification of real signals.

#### Example:

A signal with a frequency of 52.5 GHz is applied to the mixer input. Let the signal level be  $-30$  dBm. The conversion loss of the mixer is 28 dB at this frequency in the test sweep and 35 dB in the reference sweep. The user has entered a tolerance of 5 dB and a conversion loss of 28 dB. Thus, the signal is recorded with the correct level of  $-30$  dBm in the test sweep, a signal level of  $-37$  dBm is obtained in the reference sweep. As the difference (7 dB) between the levels is  $>5$  dB, the signal with the lower level is displayed, ie the signal of the reference sweep. Since the set conversion loss is adapted to the test sweep, the signal displayed on FSE has a level of  $-37$  dBm yielding incorrect level display.

The tolerance entered corresponds to the minimum S/N ratio which signals should have to ensure correct identification. If the S/N ratio of a mixer product is less than the tolerance, the decision criterion is fulfilled even if only the noise floor is recorded in the reference sweep at the frequency of this mixer product. Unwanted mixer products are therefore not detected as such by *AUTO ID*. They can only be identified by a visual comparison of the two traces using the function *SIGNAL ID*.

In order to avoid the visual identification of such unwanted mixer products it is useful to perform the measurement test in two steps:

In the first step the tolerance is set to the minimum value (0.1 dB). This enables unwanted mixer products with low S/N ratio to be detected and blanked out.

```
- [ INPUT : EXTERNAL MIXER : SIGNAL ID : AUTO ID ]  
- [ INPUT : EXTERNAL MIXER : SIGNAL ID : AUTO ID THRESHOLD : 0.1 dB ]
```

To facilitate further processing the recorded spectrum can be copied to the result memory (trace 3) and displayed.

```
- [ TRACE 1 : COPY.. : ENTER ]  
- [ TRACE 3 : VIEW ]
```

To determine the signal levels of real input signals the tolerance is to be set to the minimum value, eg 10 dB, in the second step.

```
- [ INPUT : EXTERNAL MIXER : SIGNAL ID : AUTO ID THRESHOLD : 10 dB ]
```

The real input signals (see TRACE 3) are then displayed with the correct level.

**Mixer products with low S/N ratio**

If the S/N ratio of a mixer product is less than the tolerance set with *AUTO ID THRESHOLD*, the level difference between the test sweep and reference sweep at the frequency of this mixer product is always within limits, even if the signal occurs in one of the sweeps only. Such mixer products cannot be identified by *AUTO ID*. It is therefore recommended to perform a visual comparison of the test sweep and reference sweep using the function *SIGNAL ID*.

An unwanted signal having a S/N ratio corresponding approximately to the tolerance set with *AUTO ID THRESHOLD* may not be blanked out permanently. Due to the fact that the noise display varies from one sweep to another, the S/N ratio changes and thus the level difference between the test sweep and reference sweep measured at a frequency too. As a result, the criterion for detecting unwanted signals is not fulfilled. To blank out unwanted signals permanently an almost constant noise indication is therefore required. This can be achieved by reducing the video bandwidth and/or averaging over several sweeps or by increasing the sweep time using an RMS detector. Since the average noise indication lies well below the generated noise peak values, the minimum level diminishes. For identification using *AUTO ID* signals should have this minimum level.

**Examining unwanted mixer products with small span**

With large spans in which non-modulated sinewave signals are represented as single lines, unwanted mixer products are generally completely blanked out. If the user, however, examines closer the frequency range containing a blanked signal using a small span, eg an image-frequency response, the spectrum represented in Fig. 2-4 is obtained.

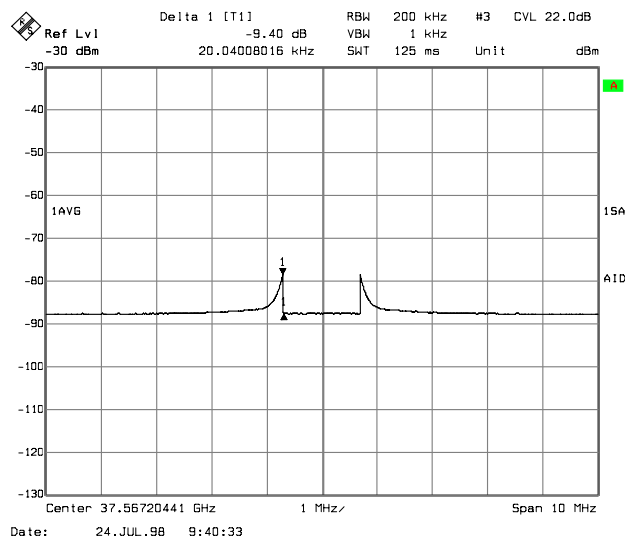

Fig. 2-4: Components of a mixer product blanked out with *AUTO ID*

There are components of a blanked signal the level difference of which is smaller than the tolerance predefined with *AUTO ID THRESHOLD* as compared with the noise floor. These components are therefore not blanked out. The tolerance chosen was 10 dB in this example which can be seen at the level difference between marker and delta marker (display 'Delta 1 [T1]').

**Using *AUTO ID* with large spans**

As already described, the comparison between test sweep and reference sweep is performed pixel by pixel. A trace comprises 500 such pixels in FSE. However, the number of the frequency steps (so-called bins) of a sweep is much higher so that the pixel information contains several frequency steps. The

selected detector defines which of the signals measured at these different partial frequencies will be displayed.

If unwanted mixer products represented at frequencies which slightly differ from each other occur in the test sweep and reference sweep, the two mixer products from the test sweep and the reference sweep are displayed by the same pixel. They will not be detected as unwanted mixer products by *AUTO ID* and therefore not blanked out. Illustration of this follows:

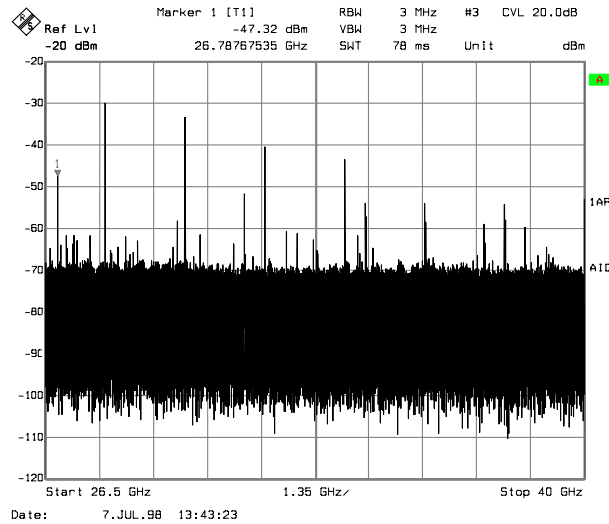

Fig. 2-5: Unwanted mixer product not detected by *AUTO ID*

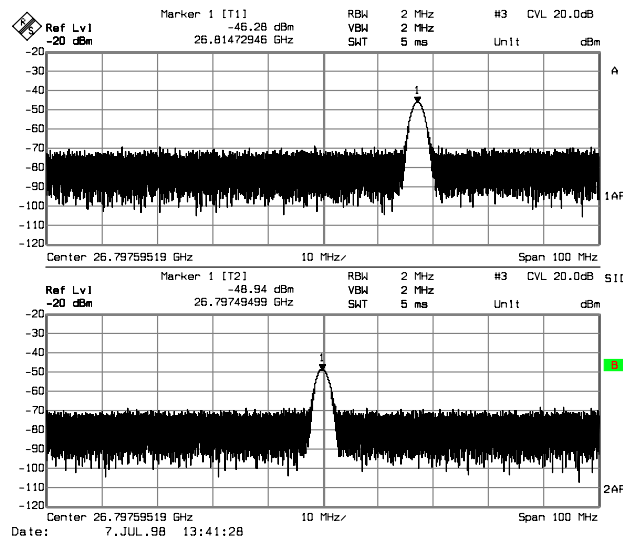

Fig. 2-6: Unwanted mixer product not detected by *AUTO ID* and examined with a small span using *SIGNAL ID*

An input signal consisting of a large number of spectral components is shown in Fig. 2-5. Unwanted mixer products are blanked out with *AUTO ID*. If a signal identified as real is examined at approx. 26.788 GHz (see marker in Fig. 2-5) with a reduced span using *SIGNAL ID* (see figure 2-6), it can be seen that the mixer products represented in the test sweep and reference sweep differ by approx. 17.2 MHz in their frequency. For the span of 1.35 GHz set in Fig. 2-5 a frequency range of 27 MHz is displayed by one pixel. Very small spans should therefore be selected to ensure correct signal identification by means of *AUTO ID*.

Display of mixer products at the same frequency

If the input signal consists of a very large number of spectral components, it will become more and more probable that two different unwanted mixer products will be displayed at the same frequency in the test sweep and reference sweep. Such a case is shown in Fig. 2-7.

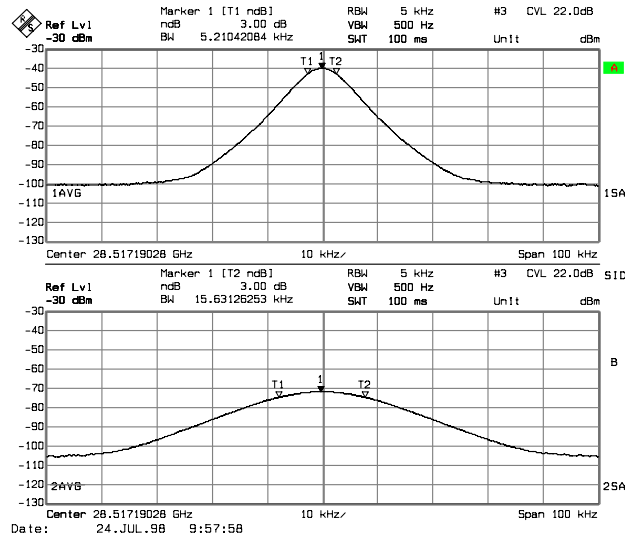

Fig. 2-7: Different mixer products represented at the same frequency in the test sweep and reference sweep

The trace recorded in the test sweep is displayed in the upper part of the screen. This is the representation of the spectrum analyzer IF filter (the 3 dB bandwidth of the displayed signal corresponds to the set IF bandwidth). If, however, the 3 dB bandwidth (display 'BW') of the signal recorded in the reference sweep is examined, it will be found to be larger exactly by a factor of 3. This shows that the two products were generated by mixing with LO harmonics of different orders. Since the IF bandwidth of the spectrum analyzer is correctly displayed in the test sweep, this mixer product was generated by conversion with the harmonic the order of which corresponds with the order selected with *HARMONIC#* (3 in this case).

The signal recorded in the reference sweep was generated by mixing with the fundamental of the LO signal. Since the frequency axis scaling is based on the 3<sup>rd</sup> order, the mixer product or the resulting diagram of the IF filter is expanded by a factor of 3.

Automatic identification with a large span is not possible since the two mixer products are displayed at the same frequency. The diagram shown in Fig. 2-8 is obtained when examining products with a narrow span using *AUTO ID*. The user can easily recognize unwanted mixer products from the clear diagram obtained using *AUTO ID* or *SIGNAL ID*.

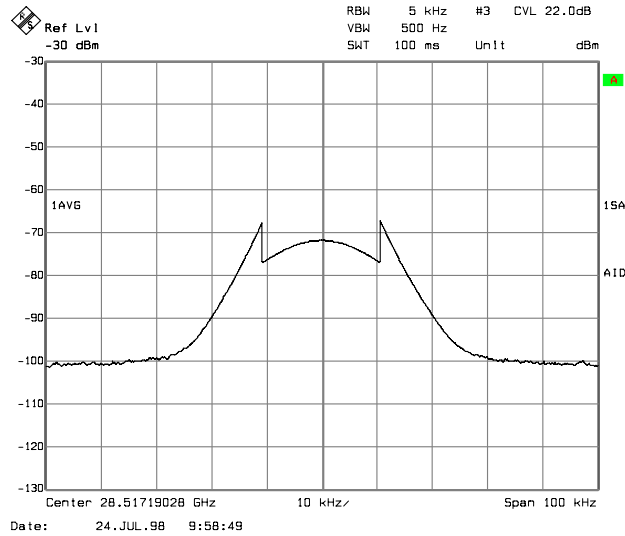

Fig. 2-8: Signal as in Fig. 2-7, but with the use of *AUTO ID*

## 2.3 Introductory Example of Operation

The following example serves to explain the operation of external mixers with FSE as well as the required settings:

A sinewave signal with  $f = 14.5$  GHz is applied to the input of a multiplier. The spectrum at the multiplier output is to be recorded in the range of 52 to 60 GHz using FSE and a 2-port mixer for the V band. The mixer used is a double-diode mixer.

**Note:** Conventions for setting the FSE during measurement:  
 [ <KEY> ] Press a key on the front panel, eg [ **INPUT** ]  
 [ <SOFTKEY> ] Press a softkey, eg [ **EXTERNAL MIXER** ]  
 [ <nn unit> ] Enter a value and terminate by entering the unit, eg [ **1 MHz** ]  
 Successive entries are separated by [:], eg [ **INPUT : EXTERNAL MIXER : BAND LOCK ON/OFF** ].

The example of operation is described in the following steps:

1. Test setup
2. Activating the external mixing and selecting the mode
3. Default setting
4. Level correction
  - 4.1 Frequency-dependent level correction
  - 4.2 Level correction with average value
5. Taking into account the cable loss in the IF path
6. Functions for signal identification

### 1. Test setup

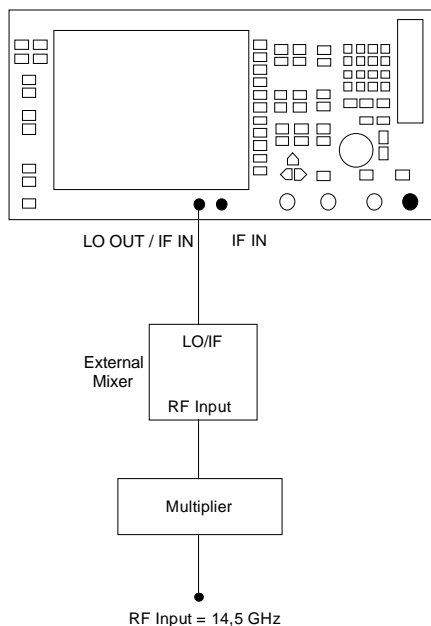

- Connect the 'LO OUT / IF IN' output of FSE to the LO/IF port of the external mixer.
- Connect the multiplier to the external mixer.
- Apply a sinewave signal with  $f = 14.5$  GHz to the input of the multiplier.



## 2. Activating the external mixing and selecting the mode

---

### Activation

- Activate the external mixing with  
- [ **INPUT** : EXTERNAL MIXER ]

---

### Selection of mode

#### *BAND LOCK ON* mode

In the *BAND LOCK ON* mode, the order of the harmonic is automatically defined by selecting a waveguide band. The harmonic of the lowest order is always used which permits coverage of the whole band. The user can also define if only even, only odd, or even and odd harmonics can be used.

The parameters can be separately set for each band. The settings performed are permanently stored and not reset by a preset or switching off the device. When using a preset the selected waveguide band is set to 'U' and FSE is switched to the mode with internal mixer. This mode permits the easy use of external harmonics mixers. For changing the band the associated mixer is to be connected and the required band selected.

#### *BAND LOCK OFF* mode

In the *BAND LOCK OFF* mode, the user can manually set the order of the harmonic. See section 2.2.2 for the calculation of the resulting frequency range.

Select *BAND LOCK ON* mode with

[ **INPUT** : EXTERNAL MIXER : BAND LOCK ON/OFF ]

## 3. Default setting

---

### Selection of the required band

- Prior to the measurement select the required band (in this case the V band) with

[ **INPUT** : EXTERNAL MIXER : SELECT BAND : BAND ]

Select the V band using the cursor keys and ENTER

#### 4. Level correction

In the *BAND LOCK ON* mode the conversion loss of the mixer can be taken into account both as a function of frequency and with an average value. The frequency-dependent level correction is used in this example for obtaining a higher precision. First select a table valid for the selected band. As an alternative, level correction based on average value can be used (see 4.2).

##### 4.1 Frequency-dependent level correction

###### Selection of table

- Activate a selection list which contains all tables stored on the hard disk of FSE with  
     [ **INPUT** : EXTERNAL MIXER : SELECT BAND  
       : CONV LOSS TABLE ]

First way:

A file with correction data already exists for the mixer used.

- Select a table valid with the cursor keys or the rollkey and confirm with ENTER.

Second way:

Such a table is not yet available.

- Create a new table with  
     *EDIT TABLE*  
     or  
     ➤ copy from a disk to the hard disk of FSE with  
       *LOAD TABLE* (see section 2.2.1.2).

- Select the file created or loaded from a disk in the selection list as described before.

A selected file is marked by √.

- Return to the *SELECT BAND* menu using  
     [ **MENU** ↑ ]

No further settings are necessary since the selected file contains all required parameters.

- Quit the *SELECT BAND* menu using  
     [ **MENU** ↑ ] key

A span is automatically set which covers the whole V band (50 to 75 GHz).

**Set frequency range**

- Set the frequency range to be examined using  
**[ FREQUENCY START : 52 GHz ]**  
 and  
**[ FREQUENCY STOP : 60 GHz ]**

**Reduction of video bandwidth**

- Reduce video bandwidth with  
**[ SWEEP COUPLING : VIDEO BW MANUAL :  
 1 MHz ]**

A correct signal identification using *AUTO ID* is thus possible (see also "Remarks concerning Signal Identification with AUTO ID" in section 2.2.4).

The display shown in Fig. 2-9 is obtained.

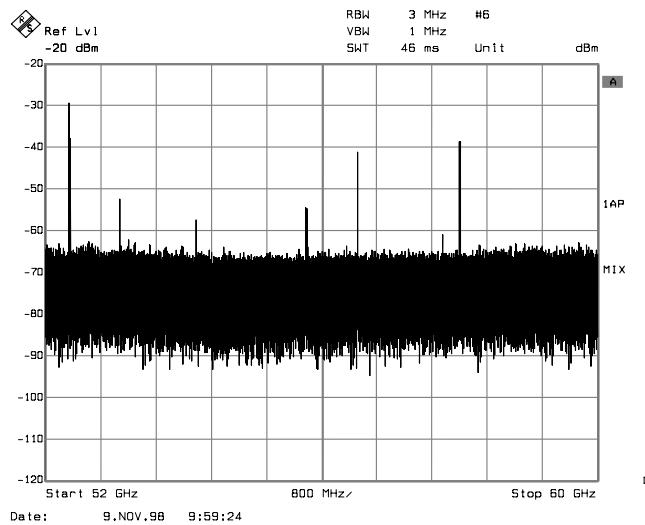

Fig. 2-9: Spectrum at the multiplier output recorded with an external mixer

#### 4.2 Level correction with average value

If an average value is to be taken into account instead of the frequency-dependent level correction, enter the following parameters for the selected band in the *SELECT BAND* table:

- Enter the average conversion loss with  
 [ **INPUT** : EXTERNAL MIXER : SELECT BAND  
 : AVG CONV LOSS LOW : {conversion loss}  
**dB** ]  
 [ **INPUT** : EXTERNAL MIXER : SELECT BAND  
 : AVG CONV LOSS HIGH : {conversion loss}  
**dB** ]  
 (relevant only if band A and even harmonics or band Q and odd harmonics are selected)
- Enter the type of mixer (in this example 2-port mixer) with  
 [ **INPUT** : EXTERNAL MIXER : SELECT BAND  
 : PORTS 2 ]
- Enter the permissible harmonic (in this example even, since a double-diode mixer is used):  
 Enable even harmonic with  
 [ **INPUT** : EXTERNAL MIXER : SELECT BAND  
 : EVEN HARMONICS ] (softkey in green background),  
 disable odd harmonic with  
 [ **INPUT** : EXTERNAL MIXER : SELECT BAND  
 : ODD HARMONICS ] (softkey in grey background).

The entered average value is taken into account for the spectrum display irrespective of the frequency. The precision that can be obtained depends on the frequency response of the mixer. With this type of level correction measurements can be easily performed at single frequencies.

#### 5. Taking into account the cable loss in the IF path

On performing level correction, the conversion loss of the mixer and also the insertion loss  $a_0$  of the cable used to tap off the IF signal are to be taken into account. This additional loss is frequency-dependent.

- Determine the insertion of the cable at the intermediate frequency  $f_{IF} = 741.4$  MHz.

For level correction with average value, add the cable insertion loss to the average conversion loss.

For frequency-dependent level correction each reference value should be increased by the insertion loss to the same extent.

- For this the cable loss can be entered via a transducer table (see section 2.4.6.1).

Such a table should only contain two reference values (band start and end) for which  $a_0$  is specified.

### 6. Functions for signal identification

The spectrum represented in Fig. 2-9 contains the input signal and also a large number of unwanted mixer products. Two functions are provided in FSE to identify real input signals. The implemented methods are described in section 2.2.4. The *AUTO ID* function is used in this example.

- Activate the function *AUTO ID* with

[ **INPUT** : EXTERNAL MIXER : SIGNAL ID :  
AUTO ID ].

To obtain a display with the correct level when using *AUTO ID*, the tolerance limit taken as a basis for the use of *AUTO ID* is to be adapted to the mixer (see explanations on the *AUTO ID* function and "Remarks concerning Signal Identification with *AUTO ID*" in section 2.2.4). The tolerance limit has been set to 5 dB in this example.

- Adapt the tolerance limit with

[ **INPUT** : EXTERNAL MIXER : SIGNAL ID :  
AUTO ID THRESHOLD : {tolerance limit} dB ].

The trace shown in Fig. 2-10 is obtained in which unwanted mixer products are blanked out.

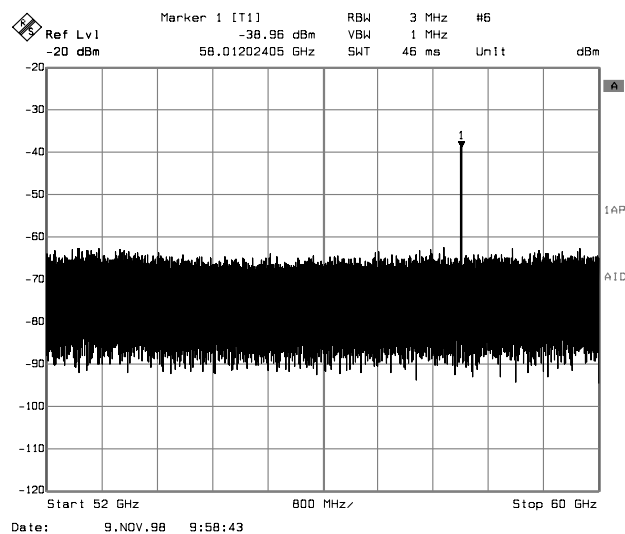

Fig. 2-10 Output spectrum of the multiplier recorded with an external mixer and *AUTO ID*

## 3 Remote Control

### 3.1 Description of IEC/IEEE-Bus Commands

#### 3.1.1 SENSE:CORRection - Subsystem

The SENSE:CORRection subsystem controls the settings of the conversion loss table. It is only active in Analyzer mode (INSTRument SANalyzer).

COMMAND	PARAMETERS	UNIT	COMMENT
[SENSE] :CORRection :CVL			
:SElect	<file_name>		
:MIXer	<string>		
:SNUMber	<string>		
:BAND	A Q U V E W F D G Y J		
:TYPE	ODD   EVEN   EODD		
:PORTs	2   3		
:BIAS	<numeric_value>	A	
:COMMeNT	<string>		
:DATA	<freq> , <level> ..	HZ , DB	
:CLEAr	--	--	no query

#### [SENSE:]CORRection:CVL:SElect <file\_name>

This command selects the Conversion Loss Table designated with <file\_name>. If <file\_name> is not available, a new Conversion Loss Table will be created.

**Parameter:** <file\_name>::= Name of Conversion Loss Table as string data with a maximum of 8 characters

**Example:** "CORR:CVL:SEL 'LOSS\_TAB' "

**Features:** \*RST value: -  
SCPI: device-specific

This command must be sent prior to the subsequent commands used to change/activate the Conversion Loss files.

#### [SENSE:]CORRection:CVL:MIXer <string>

This command defines the type designation of the mixer in the Conversion Loss Table.

**Parameter:** <string>::= Type designation of mixer with a maximum of 16 characters

**Example:** "CORR:CVL:MIX 'FSE\_Z60' "

**Features:** \*RST value: -  
SCPI: device-specific

Command SENS:CORR:CVL:SEL must be sent prior to this command.

**[SENSe:]CORRection:CVL:SNUMber** <string>

This command defines the serial number of the mixer in the Conversion Loss Table.

**Parameter:** <string>::= Serial number of mixer with a maximum of 16 characters

**Example:** "CORR:CVL:SNUM '123.4567' "

**Features:** \*RST value: -  
SCPI: device-specific

Command `SENS:CORR:CVL:SEL` must be sent prior to this command.

**[SENSe:] CORRection: CVL:BAND** A|Q|U|V|E|W|F|D|G|Y|J

This command defines the waveguide band in the Conversion Loss Table.

**Example:** "CORR:CVL:BAND E"

**Features:** \*RST value: -  
SCPI: device-specific

Command `SENS:CORR:CVL:SEL` must be sent prior to this command.

**[SENSe:]CORRection:CVL:TYPE** ODD | EVEN | EODD

This command defines the type of harmonic in the Conversion Loss Table.

**Example:** "CORR:CVL:TYPE EODD"

**Features:** \*RST value: -  
SCPI: device-specific

Command `SENS:CORR:CVL:SEL` must be sent prior to this command.

**[SENSe:]CORRection:CVL:PORTs** 2 | 3

This command defines the type of mixer in the Conversion Loss Table.

**Example:** "CORR:CVL:PORT 3"

**Features:** \*RST value: -  
SCPI: device-specific

Command `SENS:CORR:CVL:SEL` must be sent prior to this command.

**[SENSe:]CORRection:CVL:BIAS** <numeric\_value>

This command defines the bias current in the Conversion Loss Table.

**Example:** "CORR:CVL:BIAS 7mA"

**Features:** \*RST value: -  
SCPI: device-specific

Command `SENS:CORR:CVL:SEL` must be sent prior to this command.

**[SENSe:]CORRection:CVL:COMMeNT** <string>

This command defines the comment in the Conversion Loss Table.

**Parameter:** <string>::= Comment of mixer with a maximum of 60 characters

**Example:** "CORR:CVL:COMMENT 'MIXER FOR BAND U' "

**Features:** \*RST value: -  
SCPI: device-specific

Command `SENS:CORR:CVL:SEL` must be sent prior to this command.

**[SENSe:]CORRection:CVL:DATA** <freq>,<level>..

This command defines the reference values of the selected Conversion Loss Tables. The values are entered as a result of frequency/level pairs. The frequencies have to be sent in ascending order.

**Example:** "CORR:CVL:DATA 1MHZ,-30DB,2MHZ,-40DB"

**Features:** \*RST value: -  
SCPI: device-specific

Command `SENS:CORR:CVL:SEL` must be sent prior to this command.

**[SENSe:]CORRection:CVL:CLEAr**

This command deletes the selected Conversion Loss Table.

**Example:** "CORR:CVL:CLEAR"

**Features:** \*RST value: -  
SCPI: device-specific

This command is an event which is why it is not assigned an \*RST value.  
Command `SENS:CORR:CVL:SEL` must be sent prior to this command.



### 3.1.2 SENSE:MIXer - Subsystem

The SENSE:MIXer subsystem controls the settings of the external mixer. It is only active in Analyzer mode (INSTrument SANalyzer).

COMMAND	PARAMETERS	UNIT	COMMENT
[SENSE] :MIXer			
[:STATe]	<Boolean>	--	
:BLOCK	<Boolean>		
:PORTs	2   3		
:SIGNAL	OFF   ON   AUTO		
:HARMonic	<numeric_value>	--	Only query in band lock on
:TYPE	ODD   EVEN   EODD		Not in band lock off
:BAND	A Q U V E W F D G Y J		Not in band lock off
:LOSS			
[:LOW]	<numeric_value>	DB	
:HIGH	<numeric_value>	DB	Not in band lock off
:TABLE	<file_name>		
:BIAS	<numeric_value>	A	
:THReshold	<numeric_value>	DB	

#### [SENSE:]MIXer[:STATe] ON | OFF

This command activates or shuts off the external mixer.

**Example:** "MIX ON"

**Features:** \*RST value: OFF  
SCPI: device-specific

#### [SENSE:]MIXer:BLOCK ON | OFF

This command activates the BAND LOCK ON or BAND LOCK OFF mode.

**Example:** "MIX:BLOC ON"

**Features:** \*RST value: OFF  
SCPI: device-specific

#### [SENSE:]MIXer:PORTs 2 | 3

This command activates the 2- or 3-port mixer. In the BAND LOCK ON mode, the command refers to the active band selected with SENSE:MIXer:HARMonic:BAND.

**Example:** "MIX:PORT 3"

**Features:** \*RST value: 2  
SCPI: device-specific

**[SENSe:]MIXer:SIGNal** ON | OFF | AUTO

This command activates the Signal ID or Auto ID mode.

**Example:** "MIX:SIGN ON"

**Features:** \*RST value: OFF  
SCPI: device-specific

**[SENSe:]MIXer:HARMonic** 2 to 62

With BAND LOCK OFF, this command sets the nth harmonic. The command may be a query with BAND LOCK ON.

**Parameter:** <numeric\_value> := 2..62: ( max depending on the LO)

**Example:** "MIX:HARM 5"

**Features:** \*RST value: 2  
SCPI: conforming

**[SENSe:]MIXer:HARMonic:TYPE** ODD | EVEN | EODD

With BAND LOCK ON, this command sets the type of harmonic.

**Example:** "MIX:HARM:TYPE EODD"

**Features:** \*RST value: EVEN  
SCPI: device-specific

**[SENSe:]MIXer:HARMonic:BAND** A|Q|U|V|E|W|F|D|G|Y|J

With BAND LOCK ON, this command sets the active band.

**Example:** "MIX:HARM:BAND E"

**Features:** \*RST value: U  
SCPI: device-specific

**[SENSe:]MIXer:LOSS[:LOW]** <numeric\_value>

This command sets the conversion loss of the mixer.

**Example:** "MIX:LOSS -12DB"

**Features:** \*RST value: 0 dB  
SCPI: conforming

**[SENSe:]MIXer:LOSS:HIGH** <numeric\_value>

With BAND LOCK ON, this command sets the conversion loss of the mixer for higher harmonics in bands with two harmonics (band A: even harmonics, band Q: odd harmonics).

**Example:** "MIX:LOSS:HIGH -14DB"

**Features:** \*RST value: 0 dB  
SCPI: device-specific

**[SENSe:]MIXer:LOSS:TABLE <file\_name>**

This command sets a conversion loss table.

**Parameter:** <file\_name> := DOS file name

**Example:** "MIX:LOSS:table mix\_1"

**Features:** \*RST value: no table set  
SCPI: device-specific

**[SENSe:]MIXer:BIAS <numeric\_value>**

This command sets the bias current.

**Example:** "MIX:BIAS 7mA"

**Features:** \*RST value: 0 A  
SCPI: conforming

**[SENSe:]MIXer:THReshold <numeric\_value>**

This command determines the maximum permissible level difference between measurement and reference sweep in AUTO ID mode.

**Parameter:** <numeric\_value> := 0.1 ... 100 dB

**Example:** "MIX:THR 20"

**Features:** \*RST value: 10  
SCPI: device specific

### 3.2 Softkeys and Related IEC/IEEE-Bus Commands

INPUT	
MIXER INTERNAL	[SENSe:]MIXer[:STATe] OFF
MIXER EXTERNAL	[SENSe:]MIXer[:STATe] ON
BAND LOCK ON OFF	[SENSe:]MIXer:BLOCK ON OFF
SELECT BAND	--
BAND	[SENSe:]MIXer:HARMonic:BAND A Q U V E W F D G Y J
EVEN HARMONICS	[SENSe:]MIXer:HARMonic:TYPE ODD EVEN EODD
ODD HARMONICS	[SENSe:]MIXer:HARMonic:TYPE ODD EVEN EODD
PORTS 2 3	[SENSe:]MIXer:PORTs 2 3
BIAS	[SENSe:]MIXer:BIAS <value>
ACCEPT BIAS	--
AVG CONV LOSS LOW	[SENSe:]MIXer:LOSS[:LOW] <value>
AVG CONV LOSS HIGH	[SENSe:]MIXer:LOSS:HIGH <value>
CONV LOSS TABLE	--
EDIT TABLE	--
TABLE NAME	[SENS:]CORRection:CVL:SElect <name>
VALUES	[SENSe:]CORRection:CVL:DATA <x1-val>,<y1-val>,<x2-val>,... Input of further values in CVL table: [SENSe:]CORRection:CVL:MIXer <string> [SENSe:]CORRection:CVL:SNUMber <string> [SENSe:]CORRection:CVL:BAND A Q U V E W F D G Y J [SENSe:]CORRection:CVL:TYPE ODD EVEN EODD [SENSe:]CORRection:CVL:PORTs 2 3 [SENSe:]CORRection:CVL:BIAS <value> [SENSe:]CORRection:CVL:COMMeNt <string>
INSERT LINE	--
DELETE LINE	--

COPY TABLE	--
SAVE TABLE	Is saved with each change of value
PAGE UP	--
PAGE DOWN	--
NEW TABLE	See Softkey EDIT TABLE
LOAD TABLE	--
DELETE TABLE	[SENSe:]CORRection:CVL:CLear
PAGE UP	--
PAGE DOWN	--
DEFAULT SETTINGS	--
HARMONIC#	[SENSe:]MIXer:HARMonic <value>
PORTS 2 3	[SENSe:]MIXer:PORTs 2 3
AVG CONV LOSS	[SENSe:]MIXer:LOSS[:LOW] <numeric_value>
BIAS	--
BIAS	[SENSe:]MIXer:BIAS <numeric_value>
BIAS OFF	--
SIGNAL ID	--
SIGNAL ID	[SENSe:]MIXer:SIGNAL OFF ON
AUTO ID	[SENSe:]MIXer:SIGNAL OFF AUTO
AUTO ID THRESHOLD	[SENSe:]MIXer:THReshold <numeric_value>

## 4 Checking the Rated Specifications

### 4.1 Test Instructions

The rated specifications of the analyzer are tested after a warm-up time of at least 30 minutes and overall calibration. Only in this case can the compliance with the guaranteed data be ensured.

Values given in the following sections are not guaranteed. Only the technical specifications of the data sheet are binding.

#### Measurement equipment required for performance test

Table 4.1-1 Measurement equipment and accessories

Item	Type of equipment	Specifications recommended	Recommended equipment	R&S Order No.	Use
1	Power sensor	Frequency 7.5 GHz to 15.2 GHz maximum power > 40 mW RSS referred to indicated power $\leq 2.5\%$	NRV-Z51	0857.9004.02	4.1.1
2	Power meter		NRVD	0857.8008.02	4.1.1
3	Attenuator	Fixed attenuation 10 dB up to 18 GHz	Wiltron 41KA-10		4.1.1

#### 4.1.1 Checking the LO Level

Test equipment:

- power sensor (item 1)
  - frequency range 7.5 MHz to 15.2 GHz
  - maximum power  $P_{\max} \geq 40$  mW
  - RSS  $\leq 2.5\%$  referred to indicated power
  - impedance  $Z = 50 \Omega$
- power meter (item 2)
- attenuator with 10 dB fixed attenuation (item 3)

Power meter settings:

- Connect power sensor to power meter and carry out function 'ZERO' when no signal is applied to the power sensor.

FSE settings:

- [ **SYSTEM PRESET** ]
- [ **INPUT** : MIXER EXTERNAL : BAND LOCK ON / OFF ]  
toggle to BAND LOCK OFF
- [ **INPUT** : MIXER EXTERNAL : HARMONIC# : **20** : **ENTER** ]
- [ **INPUT** : MIXER EXTERNAL : BIAS : BIAS OFF ]
- [ **FREQUENCY SPAN** : ZERO SPAN ]
- [ **FREQUENCY CENTER** :  $\{f_{\text{Center}}\}$  ]  
see table 4.2.1 (item 1) of performance test report for values of  $f_{\text{Center}}$

Test setup: - Connect power sensor via 10 dB-attenuator to port 'LO OUT / IF IN' of the FSE.

Measurement: Determine level of the LO-signal  $L_{LO,meas}$  with the power meter. Due to the harmonic number ( $n = 20$ ) the center frequency  $f_{Center}$  is twenty times higher than the frequency of the LO-signal. See table 4.2-1 (item 1) of the performance test report for values of  $f_{Center}$ . To achieve higher accuracy it is recommended to compensate the frequency response of the power sensor.

The LO-level  $L_{LO}$  can be calculated as

$$L_{LO} = L_{LO,meas} + 10 \text{ dB}$$

Nominal level: +15.5 dBm  $\pm$  3 dB

## 4.2 Performance Test Report

**Note:** *The values given in the datasheet are the guaranteed limits. Due to measurement errors these limits must be extended by the tolerance of the measuring equipment used in this performance test.*

Table 4.2-1 Performance test report

Item No.	Characteristic	Test to section	Min. value	Actual value	Max. value	Unit
1	LO-level	4.1.1				
	$f_{Center}$					
	150.7414 GHz		12.5	————	18.5	dBm
	160.7414 GHz		12.5	————	18.5	dBm
	170.7414 GHz		12.5	————	18.5	dBm
	180.7414 GHz		12.5	————	18.5	dBm
	190.7414 GHz		12.5	————	18.5	dBm
	200.7414 GHz		12.5	————	18.5	dBm
	210.7414 GHz		12.5	————	18.5	dBm
	220.7414 GHz		12.5	————	18.5	dBm
	230.7414 GHz		12.5	————	18.5	dBm
	240.7414 GHz		12.5	————	18.5	dBm
	250.7414 GHz		12.5	————	18.5	dBm
	260.7414 GHz		12.5	————	18.5	dBm
	270.7414 GHz		12.5	————	18.5	dBm
	280.7414 GHz		12.5	————	18.5	dBm
	290.7414 GHz		12.5	————	18.5	dBm
300.7414 GHz	12.5	————	18.5	dBm		
303.6586 GHz	12.5	————	18.5	dBm		